

# INSTRUCTIONAL PRODUCTS CATALOG

2019 – 2020



AMERICAN  
PRINTING  
HOUSE 

◆  
◆  
◆

**We're Proud  
to Introduce  
This Year's  
New and  
Revised  
Products!**

◆  
◆  
◆

Adapted Science Materials Kit.....	66
Antique Ivory Opaque Paper <b>R</b> .....	118
BrailleBuzz.....	85
Braille Datebook <b>R</b> .....	155
Braille Trail Reader LE.....	5
Building on Patterns (BOP) Prekindergarten.....	106
Brailleable Labels and Sheets <b>R</b> .....	87
Code Jumper.....	7
Crossings With No Traffic Control.....	136
Crossword.....	162
CVI Book Builder.....	122
Decision Making Guide.....	123
Early Braille Trade Books: Rigby, Non-Fiction <b>R</b> .....	89
Earth Science Tactile Graphics.....	68
Every Child Can, VIPS Video.....	41
EZ Track Calendar <b>R</b> .....	158
Flip-Over FACES App.....	200
Four Little Corners.....	23
Four Line 8-dot Slate.....	92
Functional Skills Assessment.....	153
Illinois Braille Series, UEB <b>R</b> .....	167
InSights Art Calendar 2020 <b>R</b> .....	171
Jupiter Portable Magnifier.....	144
Laptime and Lullabies.....	20
Lighting Guide Kit <b>R</b> .....	131
Math Flash (Alexa Skill).....	143
Mini-Lite Box Overlays.....	128
O&M Trivia (Alexa Skill and Google Action).....	139
Paint By Number Safari: Under the Sea.....	76
PermaBraille <b>R</b> .....	116
Place Value Setter.....	48
See Like Me: Low Vision Simulators.....	123
Six Little Dots Game of Cards.....	23
Sunu Band.....	152
Tactile Book Builder Kit.....	86
UEB Math Tutorial.....	51
White Braille Paper 8 1/2 X 11 Unpunched <b>R</b> .....	115
Woodcock-Johnson (WJ IV) Braille Adaptation.....	18

# APH ConnectCenter

**Reliable, free information for all ages on virtually every aspect of vision loss!**



## APH ConnectCenter Resources

- **APH Information & Referral 800 Number** provides free information on virtually any topic related to visual impairment and blindness. Call toll-free **1-800-232-5463** (U.S. and Canada) or email **info@aph.org**
- **Directory of Services** lets anyone find services in his or her local area with a simple search. Lists over 2,000 agencies in the U.S. and Canada.
- **FamilyConnect.org** gives parents of children who are visually impaired a place to find resources and support.
- **APHCareerConnect.org** provides career exploration tools and job-seeking guidance for individuals with vision loss and professionals who work with them.
- **VisionAware.org** helps adults who are losing their sight continue to live full, independent lives by providing daily living techniques and a supportive online community.

## Preserving Vital Content, Building for the Future

APH is honored to be preserving these vital resources and building them for the future.

Users will notice lower activity on the websites until the fall of 2019 while APH completes needed technical changes. Most current content on the sites will continue to be available and APH will continue the dialog with users through email, Facebook, and Twitter.



## Mission Statement

The American Printing House for the Blind promotes independence of people who are blind and visually impaired by providing specialized materials, products, and services needed for education and life.

## Corporate Status

The American Printing House for the Blind, Inc. is a 501(c)(3) non profit organization. Gifts, therefore, are tax deductible.



## President's Message

I'm pleased to present our 2019-20 Instructional Product Catalog. The catalog is an APH tradition, providing information about our products in an easy-to-use print format and organized by category.

While the catalog may be the usual way you learn about our products, I encourage you use it in conjunction with our new, fully accessible website. Our new site provides a premier shopping experience for our customers, including detailed product information, in an easy-to-access storefront. On each product page, you will find a variety of photos, detailed descriptions (including product features, what is included, and spec information), a list of replacement parts, and a link to download manuals (where applicable).

We would like to extend a sincere thank you to everyone who provided feedback on the new site design and content - from our EOTs, to teachers who participated in focus groups at conferences, to our staff who took this feedback and used it to create a new and improved experience for our customers. We hope you will take the time to explore our new website and online shop.

Welcome everyone,

Craig Meador

# Table of Contents

<b>Assessment</b> .....	12
<b>Early Childhood</b> .....	19
<b>Core Curriculum</b>	
English Language Arts .....	43
Mathematics .....	47
Science and Health .....	65
Social Studies: History, Geography, and Economics .....	72
Fine Arts .....	75
Business and Vocational Education .....	78
Physical Education .....	79
<b>Expanded Core Curriculum</b>	
Communication Modes and Literacy Education .....	83
Visual Efficiency and Low Vision .....	121
Orientation and Mobility .....	135
Assistive Technology and Electronics .....	142
Career Education and Transition .....	148
Self-Determination .....	150
Daily Living and Social Interaction .....	151
Recreation and Leisure .....	160
<b>Videos</b> .....	165
<b>Resources for Professionals</b> .....	166
<b>Gifts</b> .....	171
<b>Other Services from APH</b> .....	172
<b>How to Order, Returns Policy, Warranty and Repair Policy</b> .....	177
<b>Index</b> .....	186



## Prices Effective June 1, 2019

**Note:** The products offered by the American Printing House for the Blind are instructional/teaching materials and are intended to be used by trained professionals, parents, and other adults with students who are blind and visually impaired.



**Warning:** These materials are not intended as toys for use by children in unstructured play or in an unsupervised environment.



# Braille Tales

Early reading develops braille awareness skills and an enthusiasm for literacy in the hearts of young children. That's why APH offers free print/braille books for preschoolers who are blind or visually impaired.

If you live in the United States and have a preschooler who is blind (5 years of age or younger) we will send you six free print/braille books per year. Braille Tales books allow children to become interested in braille from a young age, encouraging them to be lifelong braille readers. We also send Braille Tales to adults who are blind and want to read to their preschoolers.

APH has partnered with the Dolly Parton Imagination Library which offers free books to children across the country. Through a partnership with APH, 6 of those same books are chosen each year to be our Braille Tales books. Braille labels are added to each book, bringing the whole family together by allowing you to read braille or print.

To learn more visit [aph.org](http://aph.org) and search Braille Tales, or email [BrailleTales@aph.org](mailto:BrailleTales@aph.org).

Eleanor is 9 months old and loves when I read Braille books to her. I run her fingers along the Braille while we read. If I read her books without Braille, she frantically starts feeling all over the pages for the bumps she is getting familiar with! Thank you for providing blind babies with Braille books!

– Lorraine Bartholomew, Parent

# What's the best way to learn? Your way.

Start your students' braille journey with a positive technology experience that allows them to discover the joys of reading and writing.

The Braille Trail Reader LE is a customized, limited cid:7744E1BB-B603-4018-AF62-1606DA5355F0@aph.org edition version of HumanWare's Brailliant™ B14 braille display, developed exclusively for teachers and students. The proprietary Braille Trail Reader File Transfer Windows® App enables teachers to easily read and transfer files to and from their students' Reader. Students can take notes, and create, edit, and read text and braille files, enhancing the classroom experience.



## Features

- 14 high-quality braille cells and 8-dot braille input keys
- Simple navigation methods and changeable braille codes
- Comfortable typing experience with a note-taker style spacebar
- Touch sensor routers and HumanWare signature thumb keys
- Navigation joystick
- Durable, red case
- Internal intelligence:
  - Clock application and stop watch
  - Wake up iOS device
  - Stand-alone note application (with or without pairing to an iPhone or iPad)

## Includes

- Braille Trail Reader LE
- Durable carrying case and lanyard
- Micro-USB charging cable
- Quick Start Guide (print)
- Command Summary (braille)
- Decorative Braille Bug® sticker

The Braille Trail Reader LE is only available during the 2019 school year. Visit [braillebug.org](http://braillebug.org) for additional resources, including more information about braille literacy, and engaging and inclusive student activities.

**1-07421-00** \$995.00

# APH Press

American Printing House for the Blind

## Our beginning as a printing house is just one chapter of our story.

APH is pleased to be the distributor of AFB Press and APH Press textbooks. To order, please visit the shopping page at [aph.org](http://aph.org), or contact Sarah Bush, APH Customer Service, at 502-899-2306 or [sbush@aph.org](mailto:sbush@aph.org).

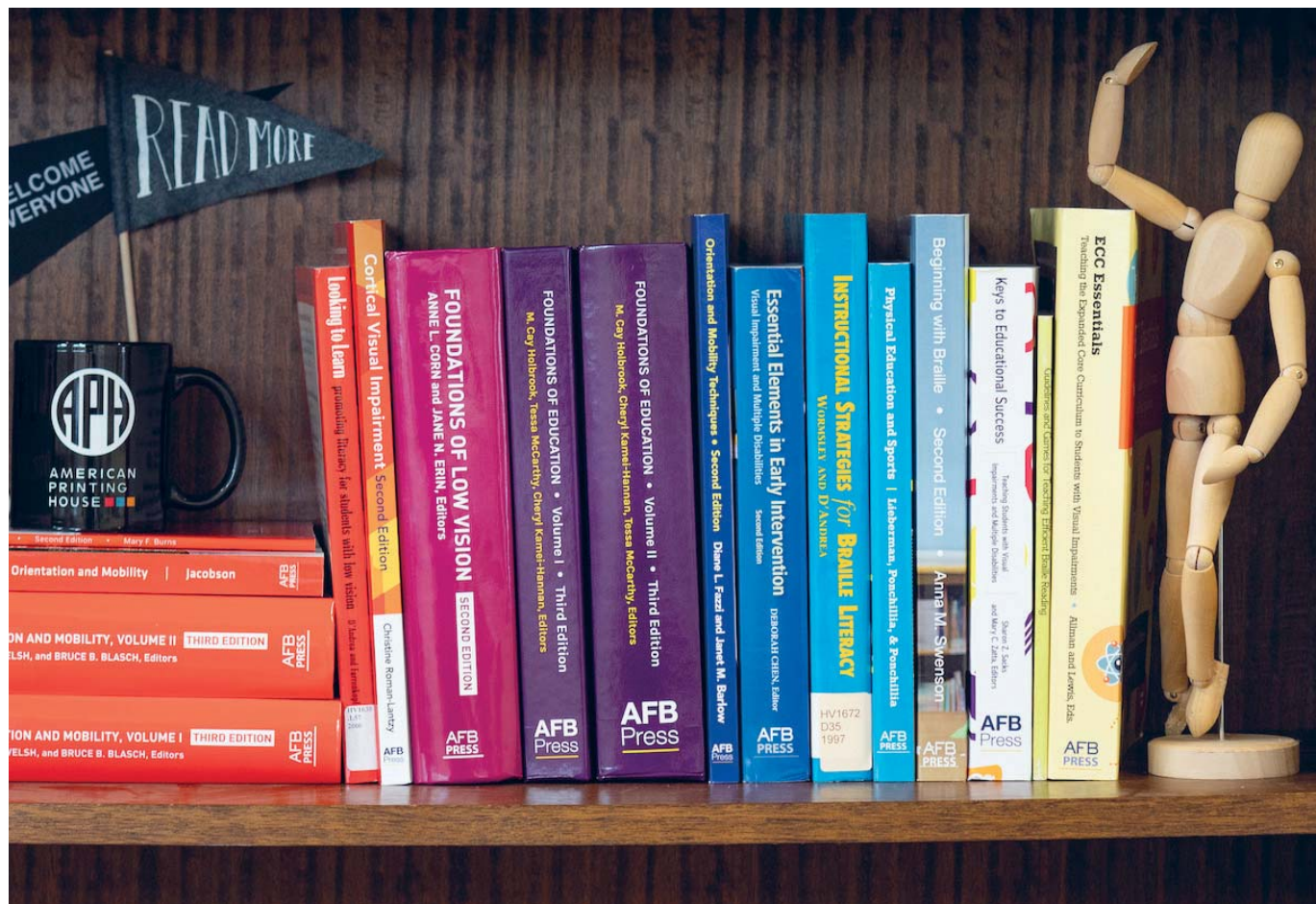





# code jumper™

Code Jumper™ is the newest innovation to assist children, regardless of their level of vision, in learning computer coding and programming skills. Brightly colored plastic pods with oversized buttons and knobs are connected by “jumper cables” (thick cords) to physically create computer code that can tell stories, make music, and even crack jokes.

Developed by Microsoft® and distributed by APH, this educational toy bridges the skills gap and opens up the world of coding to every student.

## Features of Code Jumper include

- Makes coding immediately accessible for kids who are blind or visually impaired, and who also have no prior computing experience.
- An intuitive system designed to be inclusive, enabling all students to work together and build confidence through socialization, cooperation, critical thinking, and hands-on learning.
- Teaches underlying skills that can empower the next generation to pursue meaningful careers in computer science.
- Any teacher can facilitate Code Jumper lesson plans without prior computer science experience! A full library of curricula for coding, including teacher guidance and student activities, is also included.

Code Jumper will be available in 2019 and is quota fund eligible.

For more information, visit [www.CodeJumper.com](http://www.CodeJumper.com).



# What is the Core and Expanded Core Curriculum?

## Core Curriculum

Educators define core curriculum as the knowledge and skills a student should learn by high school graduation. This foundation, for almost all learning, is generally related to academic subjects.

## Expanded Core Curriculum

The American Printing House for the Blind, and most professionals in the field, firmly believe that students who have a visual impairment need an expanded core curriculum that encompasses additional areas of learning. Experiences and concepts casually and incidentally learned by sighted students must be systematically and sequentially taught to students with a visual impairment.

**Dr. Philip Hatlen** (1934–2016) authored the introductory copy at the beginning of each of the Expanded Core Curriculum sections in this catalog. Dr. Hatlen’s numerous accomplishments included the original development of the Expanded Core Curriculum. Dr. Hatlen had many connections at APH, including acting as Ex Officio Trustee and our Executive in Residence. Read more about the extraordinary Dr. Hatlen at the Hall of Fame on our website, [aph.org](http://aph.org), please search for Hall of Fame inductees Hatlen.

# 2019-20 APH Catalog

Thank you to everyone who provided feedback on our 2018-19 catalog. We heard you, and in this year’s catalog you will see we have included more photos of our products. We will also continue to offer a fully accessible version of the catalog on our website.

Do you have other suggestions for improving our catalog? If so, please let us know by emailing [catalogs@aph.org](mailto:catalogs@aph.org).

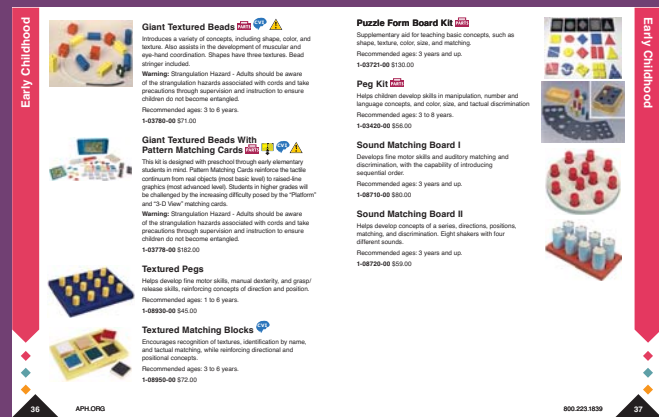

## Catalog Production Credits

**Design:** Laura Greenwell, Anthony Jones, Stephanie Lancaster

**Editors:** MaryGen Boley, Leslie Farr Knox

**Project Assistants:** MaryGen Boley, Anthony Jones, Leslie Farr Knox

**Committee:** MaryGen Boley, Anne Durham, Doug Eder, Laura Greenwell, Kate Herndon, Anthony Jones, Leslie Farr Knox, Stephanie Lancaster, Jim Kreiner, Heather MacKenzie, Craig Meador, Chris Prentice, Cathy Senft-Graves, Larry Skutchan

## Website Offers a Wealth of CVI Information

APH offers free information about Cerebral/Cortical Visual Impairment, or CVI, to consumers via the web. Sections include a definition of CVI, intervention strategies, advocacy and resources, and much more.

The website is an evolving resource of current knowledge on this leading cause of visual impairment. It provides information from medical, educational, and parental perspectives, as well as allowing an open door to communicate on the topic.

To explore the CVI website, go to **aph.org** and search for CVI.

## Suggested APH Products for Children With CVI

Following are products that may be appropriate for use with children who have Cerebral/Cortical Visual Impairment. Comprehensive assessment should determine which products are best matched to your learner's needs.

All-In-One Boards: 1-08833-00, 1-08836-00	91
Bright Shapes Knob Puzzles 1-03722-00	21
CVI Complexity Sequencing Kit and eBook D-03610-ED	133
CVI Book Builder 1-08825-00	122
Increasing Complexity Pegboard: 1-08160-00	124
Invisiboard: 1-08541-00	127
Joy Player 1-07089-00	34
Light Box	129
Light Box Materials Kit, Level I: 1-08670-00	130
Light Box Materials Kit, Level II, full kit: 1-08680-00	130
Pegs/Pegboard: 1-08665-00	131
Familiar Object Picture Cards: 1-08666-00	132
Mini-Lite Box: 1-08661-00	129
Mini-Lite Box Overlays 1-08659-00	128
Picture Maker: Wheatley Tactile Diagramming Kit: 1-08838-00	141
Sensory Learning Kit (SLK): 1-08611-00	34
Spangle Tangle 1-08755-00	39
Spinner Overlays for the Light Box: 1-08692-00	128
Swirly Mats: CVI: 1-08153-00	132
Swirly Mats II: CVI: 1-08158-00	133
TADPOLE Kit (selected items): 1-08155-00	14
ToAD Kit (selected items): 1-08152-00	14
VIPS@Home Parent Empowerment Program: 8-00075-00, 8-00076-00, 8-00078-00	33



## Service for 160 Years

Since 1858, APH has been creating unique products for people who are visually impaired, blind, and deafblind. APH products are designed for infants, preschoolers, students, and adults, both in education and in daily living.

## Recommended Ages for Products

Recommended ages for products are expressed as functional age rather than chronological age.

## Prices and Types of Funds Accepted

All items in this catalog can be purchased with regular funds (i.e. checks, credit cards, or purchase orders). Most items can also be purchased with Federal Quota funds through an Ex Officio Trustee. Refer to the

inside back cover for an overview of Federal Quota. Prices in this catalog are effective June 1, 2019. Prices are subject to change without notice.

## Ordering on the Web

You can browse and search for APH products, then order using Federal Quota funds, a purchase order, or a credit card.

## Questions?

APH provides a toll-free number for:

- Placing credit card orders
- Questions about existing orders or status of products under repair
- Questions about products and services
- Technical Support

Call Monday through Friday from 8:00 a.m. to 4:30 p.m. Eastern Time: 1-800-223-1839 (U.S. and Canada) or email [info@aph.org](mailto:info@aph.org)

## Important Icon Legend



### CVI Icon

Products with this icon may be appropriate for learners diagnosed with CVI. Comprehensive assessment should determine which products are best matched to your learner's needs.



### Safety Warnings Icon

Please note and follow the small parts choking hazard and other warnings indicated for certain APH products.



### UEB Icon

Products with this icon are transcribed in Unified English Braille (UEB).



### Replacement and Optional Parts Available Icon

Products with available replacement parts are marked with this icon. Refer to the Replacement Parts Catalog on our website.



### Downloadable Manuals

Most APH products have manuals available for immediate, free-of-charge downloading for printing or embossing as needed. Please visit [aph.org](http://aph.org) to download a manual.



### New Product



### Revised Product

# APH Products for Sensory Impairments and Additional Disabilities

Children and adults with both visual impairments and multiple disabilities are diverse in their strengths and interests. APH has long embraced inclusive strategies in product development, resulting in many products appropriate for individuals who have visual and/or aural impairments, and other disabilities.

## APH Intervention Continuum – Three Sequential Kits

APH recommends that learners use the following three products sequentially:

### **Sensory Learning Kit (SLK)** — page 34

This Kit is an extensive set of sensory items, assessments, and written materials that help the most significantly challenged learners increase their curiosity and attention while developing specific skills.

### **SAM: Symbols and Meaning** — page 95

A kit for learners with visual and multiple impairments, and pre-school children with visual impairments who are beginning to use symbols.

### **Tactile Connections: Symbols for Communication** — page 95

This kit helps learning partners create a tactile card communication system for learners who lack a formal means of communication. The versatility of the kit allows for symbolic skill expansion from concrete to more abstract, and from single-word to multi-word communications.

### **Child-guided Strategies: The Van Dijk Approach to Assessment** — page 16

An easy-to-use guidebook with an accompanying DVD or flash drive that follows the assessment of a baby, a young child, and a teenager.

### **Expandable Calendar Boxes** — page 96

A single “now” or “anticipation” box lets a learner know what is about to happen in his world. Two boxes together provide the concept of “now and next.” Three boxes create a calendar.

### **Joy Player** — page 34

APH designed its personal music player to accommodate individuals of any age who have multiple challenges. This digital music player plays WAV and MP3 files.

### **Reach & Match Learning Kit and Inclusive Learning Program** — page 21

This inclusive-designed product encourages self-teaching and group interaction. Active learning teaches colors, shapes, textures, orientation, and print letters and braille. Children learn concepts of near/far and front/back.

### **Spangle Tangle** — page 39

The reflective twisty Spangle Tangle helps students learn motor, problem-solving, cognitive, self-care, social, and pre-braille skills. This fun kit includes self-sticking stands for use on tabletop or wheelchair tray.

# Assessment Section Index



Accessible Multiple Choice Answer Sheets: Braille, Large Print, Pop-A-Dot .....	17
Boehm-3 Kits .....	13
Brigance Diagnostic Comprehensive	
Inventory of Basic Skills .....	15
Inventory of Early Development .....	16
Child-guided Strategies: The Van Dijk Approach to Assessment .....	16
Functional Vision and Learning Media Assessment .....	15
NewT Kit .....	14
TADPOLE Kit .....	14
Teacher's Pet Software .....	16
ToAD Kit .....	14
Woodcock-Johnson (WJ IV) <b>N</b> .....	18

## Assessment Related Products

All-In-One Boards .....	91
CVI Complexity Sequences .....	133
Functional Skills Assessment .....	153
Increasing Complexity Pegboard .....	124
Invisiboard .....	127
Light Box, Materials .....	130
Math Flash .....	50, 143
Quick Pick Series .....	60
Reach for the Stars .....	24
SAM: Symbols and Meaning .....	95
Sensory Learning Kit (SLK) .....	34

## Boehm-3 K-2

Boehm-3 K-2 measures 50 basic concepts relevant to school success, helping identify students who may not have the learning experiences necessary to understanding key concepts. Developed for easy use with English- and Spanish-speaking students.

**Note:** Boehm-3 Examiner’s Manual is available through Pearson: <http://www.pearsonclinical.com/language/products/100000188/boehm-test-of-basic-concepts-thirdedition-boehm-3.html>

Full reliability and validity data for children without visual impairment can be found in the Examiner’s Manual (see link above), but does not apply to this adaptation.

Everything needed to administer the Boehm-3 K-2 to children with visual impairments is included in these kits. The Boehm-3 Kits can be used with students diagnosed with CVI by applying the same accommodations that they use in school.

Recommended grades: K–2.

### Big Picture

1-03883-00 \$384.00

### Tactile

1-03884-00 \$519.00



## Boehm-3 Preschool

Boehm-3 Preschool measures 26 basic concepts relevant to the preschool/early childhood curriculum. This test helps identify children who lack understanding in basic rational concepts so you can provide intervention sooner, increasing their chance of success in school. The Big Picture Kit manual and record forms are available in English and Spanish.

**Note:** Boehm-3 Preschool Examiner’s Manual is available through Pearson: <http://www.pearsonclinical.com/psychology/products/100000161/boehm3-preschool.html>

Full reliability and validity data for children without visual impairment can be found in the Examiner’s Manual (see link above), but does not apply to this adaptation. Everything needed to administer the test to children with visual impairment is included in these kits.

The Boehm-3 Preschool Kits can be used with students diagnosed with CVI by applying the same accommodations that they use in school. There is no background complexity, and the drawings have already been simplified for use with students with low vision.

Recommended grade: Pre-K.

### Big Picture

1-03880-00 \$291.00

### Tactile

1-03882-00 \$564.00





## NewT Kit

This Kit includes accessible tools and activities for use with Functional Vision and Learning Media Assessment (NewT). It has everything you need to complete the Observations, Functional Vision Assessment, and Learning Media Assessment sections of the FVLMA.

### Includes

Sample graphs, maps, dictionary entries, reading samples, diagrams, news clippings, and catalogue pages for grade levels K–12.

Recommended grades: Pre-academic to academic, K–12.

**1-08149-00** \$959.00



## TADPOLE Kit

Tools and Activities for the Development of Visual Skills (TADPOLE) is a set of standardized tools that helps practitioners perform functional vision evaluations or visual skills development activities. Similar to APH's ToAD Kit, but geared toward younger learners, TADPOLE is a natural precursor to the ToAD Program.

**Note:** Practitioners should purchase the ToAD Kit prior to using the TADPOLE Kit, since items from ToAD are needed when a student's personal items are not available.

**1-08155-00** \$321.00



## ToAD Kit

Tools for Assessment and Development of Visual Skills (ToAD) is a set of standardized tools that aids in performing functional vision evaluations or visual skills development activities. The ToAD Kit provides tools, toys, and puzzles that assist the educator as he or she performs assessments or activities. ToAD also serves as the Vision Modality for the Sensory Learning Kit (SLK).

Recommended ages: 2.5–5 years.

**1-08152-00** \$832.00



## Functional Vision and Learning Media Assessment (FVLMA) Kit

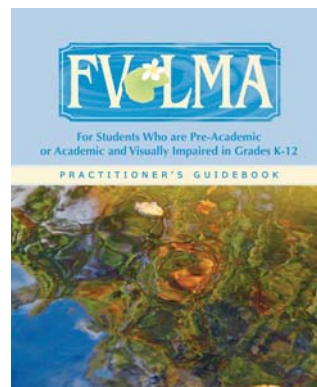

FVLMA is a user-friendly instrument that provides a framework for the systematic assessment of a student's visual functioning and needs for adapted educational media. Although not a standardized test, FVLMA has been peer-reviewed by experts in the field of blindness and field tested by teachers and students.

Recommended grades: Students who are pre-academic in K-12.

7-96151-00 \$67.00

## Brigance Diagnostic Comprehensive Inventory of Basic Skills (Green), Revised, 1999 (CIBS-R), Student Braille Edition



An adaptation of the print inventory, the student braille edition includes tactile representations of diagrams where appropriate.

Recommended grades: Pre-K-9.

5-00000-00 \$444.00

## Brigance Diagnostic Comprehensive Inventory of Basic Skills (Green), Revised, 1999 (CIBS-R), Student Large Print Edition



A criterion-referenced inventory that assesses, on an individual basis, a student's strengths or weaknesses in specific skill areas. The CIBS-R has been especially useful in support of Individual Educational Plan (IEP) development and program planning.

Recommended grades: Pre-K-9.

4-00000-00 \$153.00



## Brigance Diagnostic Comprehensive Inventory of Early Development (Yellow), APH Tactile Supplement, Revised, 1991

A criterion-referenced assessment designed to identify the level of mastery that a young child has achieved on selected skills. This information is important for planning a child's Individualized Family Service Plan (IFSP) or Individualized Educational Program (IEP).

Recommended ages: Birth–K.

**Note:** The Brigance student large print and braille editions, as well as the APH Tactile Supplement, were designed to be used only in conjunction with the print inventory. To order the print test, student record books, and other regular print materials, contact: Curriculum Associates, Inc. North Billerica, MA 800-223-0248, Fax: 800-366-1158, [www.curriculumassociates.com](http://www.curriculumassociates.com)

5-17681-00 \$192.00

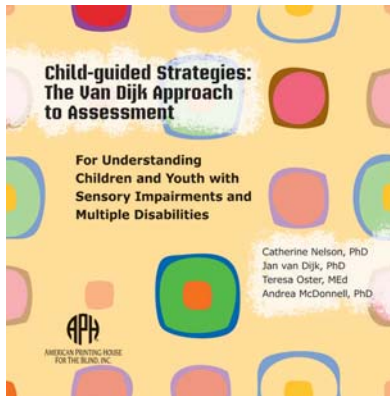

## Child-Guided Strategies: The Van Dijk Approach To Assessment

This product offers an easy-to-use guidebook with an accompanying flash drive that follows the assessment of a baby, a young child, and a teenager. The Van Dijk assessment is unique as it follows the lead of the individual learner. Critical to the process is the recognition that assessment and intervention must always occur hand-in-glove and that meaningful assessment guides intervention. This product contains the guiding principle and guidelines to conduct an assessment that follows the Van Dijk approach.

7-31001-00 \$45.00

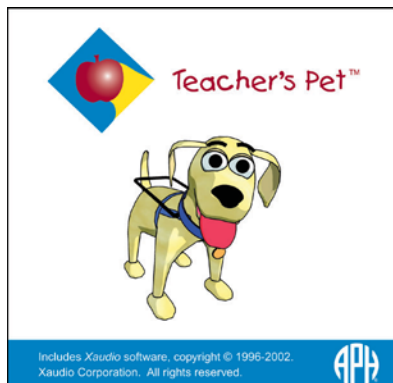

## Teacher's Pet Software

Create accessible drills, practice exercises, or tests for students who are blind and visually impaired, including both audio and large print tests. It can also record test sessions to track student progress.

Recommended ages: All (dictated by tests created).

**CD-ROM**  
D-03460-00 \$89.00

**Digital Download**  
D-03460-ED \$79.00

## Accessible Multiple Choice Answer Sheets: Braille, Large Print, Pop-A-Dot

High-contrast layouts with print and tactile elements engage students so that test-taking can be fun! Sighted peers will also love these.

Recommended ages: 8 years and up.



### Braille Answer Sheets

Fifty generic sheets with question numbers 1–40 in large print and braille, in two columns, with multiple choice braille answers a–e.

5-17003-00 \$14.00

### Large Print Answer Sheets

Formatted in two columns, with bold lines and 18-point font, these two-sided generic answer sheets have question numbers 1–40 with every other line highlighted in a contrasting color.

7-17003-00 \$16.00

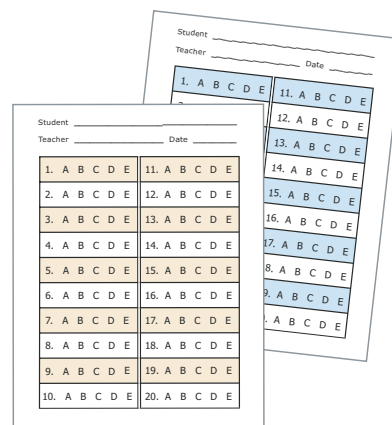

### Pop-A-Dot®

These sheets make testing fun with “memory plastic” dots that are pushed down to select an answer, but can be popped back up easily, allowing students to change their answers independently. Beginning level student sheets have one column with 10 question numbers.

Advanced level student sheets have two columns with 20 question numbers.

Pop-A-Dot (4-pk)  
1-17003-00 \$71.00

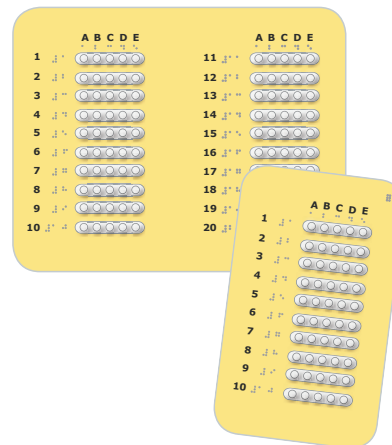

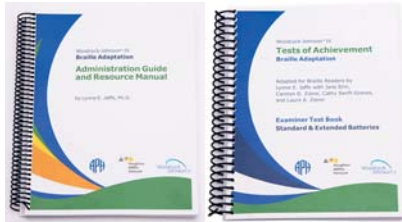

## Woodcock-Johnson IV (WJ IV) **PARTS**

The Woodcock Johnson® IV is a comprehensive set of assessments, administered individually, to identify learning difficulties and improve instructional outcomes for all ages. The assessment is comprised of three batteries: Tests of Achievement (Standard and Extended), Tests of Cognitive Abilities (Standard and Extended) and Oral Language.

The braille adaptation is comprised of a comprehensive set of assessments, administered to identify learning difficulties and improve instructional outcomes, from each of the three batteries: Tests of Achievement (Standard and Extended), Tests of Cognitive Abilities (Standard and Extended), and Oral Language.

These materials must be ordered directly from the test publisher: Customer Experience Support – Assessments, Houghton Mifflin Harcourt, 255 38th Avenue, Ste. L, St. Charles, IL 60174; 800-223-9540; Fax: 630-467-7192; **AssessmentsOrders@hnhco.com**.

**Note:** It is strongly suggested that the administrator have approved professional development training in administering the original print Woodcock-Johnson IV. Examiners must meet the qualifications for administering this assessment and have purchased the publisher materials which are referenced in the braille adaptation. The audio CD provided in the publisher kit is necessary to administer portions of the braille adaptation.

Recommended ages: 2 years and up.

**Print**  
4-66003-00 \$437.00

**Braille** **N**  
6-66001-00 \$890.00



# Early Childhood Section Index

APH SoundPage .....	30	Sensory Learning Kit (SLK).....	34
Alphabet Scramble .....	31	Select Switch.....	34
Bear Hunt .....	22	Shape Board .....	38
Bright Shapes Knob Puzzles Kit .....	21	Six Dots Game of Cards <b>N</b> .....	23
Best for a Nest, The .....	24	Six Little Dots .....	23
Developmental Guidelines for Infants With Visual Impairments.....	24	Small, Medium, & Large Circles Sets .....	38
Effective Use of Objects .....	35	Sound Adapted Tangle Ball Kit .....	39
Every Child Can, VIPS Video <b>N</b> .....	41	Sound Matching Boards .....	37
Everyday Activities Calendar .....	24	Spangle Tangle .....	39
Experiential Learning .....	25	Sticky Dots Adhesive .....	41
Fine Motor Development Materials .....	35	Tactile Treasures .....	35
Four Little Corners <b>N</b> .....	23	Tangle Toy .....	39
Giant Textured Beads .....	36	Textured Matching Blocks .....	36
HANDS ON: Functional Activities for Visually Impaired Preschoolers .....	35	Textured Pegs.....	36
Holy Moly .....	21	VIPS@Home Program .....	33
Joy Player, The.....	34	VIPS Video Library Series .....	40–41
Jumbo Work/Play Tray .....	39	What is IT? Kit.....	21
Laptime and Lullabies <b>N</b> .....	20	Work-Play Trays.....	40
Lots of Dots Series .....	42		
Moving Ahead Series.....	32	<b>Early Childhood Related Products</b>	
On the Way to Literacy Series .....	26–30	All-In-One Boards .....	91
PATTER: Preschool Attainment Through Typical Everyday Routines .....	25	APH Sound Balls .....	80
Parenting With a Visual Impairment .....	25	Boehm-3 .....	13
Parents and Their Infants with Visual Impairments .....	25	Color-by-Texture Circus Coloring Pages.....	77
Peg Kit .....	37	Color-by-Texture Marking Mats.....	77
Pumpkin Puzzles .....	31	Flip-Over Concept Books.....	105
Puzzle Form Board Kit .....	37	IntelliTactiles Pre-Braille Concepts .....	98
Reach & Match Learning Kit .....	21	Light Boxes and Materials .....	129–130
Reach for the Stars.....	24	NewT Kit .....	14
Rolling Into Place.....	41	Rib-It-Balls .....	80
Rolling Right Along Construction Kit .....	41	SAM: Symbols and Meaning .....	95
Sensory Cylinder Set .....	38	Setting the Stage .....	104
		Tactile Book Builder Kit.....	86
		Teach Me to See .....	125
		Word Associations Print/Braille Labels.....	99

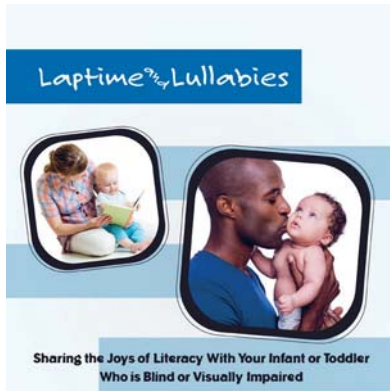

## Laptime and Lullabies

### Sharing the Joys of Literacy With Your Infant or Toddler who is Blind or Visually Impaired

With a little “thinking out of the book,” you and your little one can discover literacy activities that are enjoyable and meaningful.

Many parents with young children who are blind and visually impaired often wonder... “When should I begin to read to my baby?” or “How can I interest my toddler in books if she does not see the pictures clearly?” or “Should my young child learn to read braille?” or “What kinds of early literacy experiences can I provide for my child who is visually impaired and has additional special needs?” Laptime and Lullabies, was created for APH by Kay L. Clarke, Ph.D., to help families and their early intervention teams answer these and other questions.

#### Includes

- Handbook (contains 18 booklets)
  - First Chapters of Literacy
  - Establish Relationships
  - Share Conversations
  - Focus on Vision
  - Grow Listening Skills
  - Enhance Touch
  - Partner in Play
  - Explore the World
  - Read Together
  - Investigate Books
  - Discover Symbols
  - Experiment With Tools
  - Team Up for Literacy
  - Emergent Literacy Developmental Milestones
  - It Makes Sense to Me
  - Literacy Fun at Bath Time and Bedtime
  - Bath Time and Bedtime Activities
  - References
- Butterflies Storybook with finger puppet and Tips Card
- Where’s Little Fuzzy Storybook with Tips Card
- Flash drive with accessible files, including UEB braille ready files and studio recorded audio files

Recommended ages: Birth to 3 years.

**6-77702-00 \$119.00**

## Bright Shapes Knob Puzzles Kit

Based on the shapes used in APH's Light Box Levels I-III Kits, Bright Shapes Knob Puzzles have knobs to help with grasping. Targeted skills include hand-eye coordination, relational concepts such as in/out, directionality, shape and color recognition, comparison, and patterning. Designed to be easily viewed on the APH Light Box, or can be used on its own.

Recommended ages: 2 years and up.

1-03722-00 \$169.00

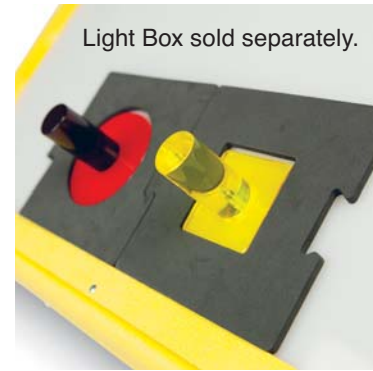

## Reach & Match Learning Kit and Inclusive Learning Program



An innovative system for students with sensory impairment and other special needs to learn and engage with their peers. Includes four large puzzle piece mats, each a different color. One side of each mat has a texture with a tactile pattern that matches corresponding tiles. The other side has the same texture but with a recessed white path. Along the path are cut-out shapes that correspond to the same tiles. The tiles are stored in a round pillow with a zipper closure that is placed in the middle.

Recommended ages: 3 years and up.

1-08816-00 \$900.00



## What is it? Kit

With an active introduction to details contributing to the whole, the child will gain the foundation for comparative thinking, leading to the ability to generalize and communicate independently.

Recommended grades: Pre-K and up.

1-03535-00 \$61.00

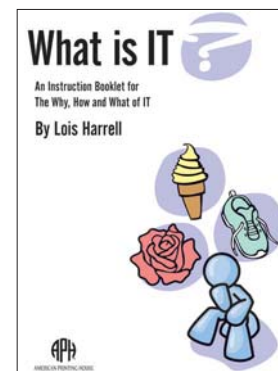

## Holy Moly

A colorful, tactile board book with rhyming text and interactive components encourages young tactual learners to use their fingers to explore. The multisensory and interactive components engage the child in a movement or action that is connected to the text in a meaningful way. Sturdy, easy-to-turn pages.

Recommended ages: Birth to 3 years.

6-77910-00 \$47.00

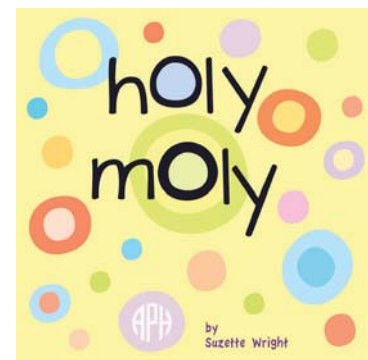



## Les Doigts Qui Rêvent (LDQR)

LDQR Storybooks have been featured in Outstanding Books for Young People with Disabilities, a catalog and exhibit organized by the International Board on Books for Young People (IBBY). IBBY is a non-profit organization representing an international network of people committed to bringing books and children together. Includes: A Touch, Six Little Dots, Six Little Dots Game of Cards, Four Little Corners, and Bear Hunt.

The Storybooks and Cards are produced for APH by the French tactile book publisher, Les Doigts Qui Rêvent (LDQR). Richly textured, collage-style illustrations with interactive features are visually attractive and have appeal for all young learners as well as adults sharing the books with a child. Illustration, design is based on research into the needs of tactual learners. Text is provided in large print and contracted UEB, provided as clear, silk-screened braille of high quality and durability.



## Bear Hunt

Invites children on a multisensory expedition toward a bear's cave. As the reader journeys across the page, sliding a small token along a path, fingers encounter tactile and audible features, such as waving grass, a silken stream, a squishy marsh, trunks of trees, and slippery "snow." Feeling inside the cave reveals a furry face with big eyes, a soft nose, and sharp teeth!

Recommended ages: 3 years and up.

6-77955-00 \$229.00





## Four Little Corners **N**

This tactile adaptation of Jérôme Ruillier’s print storybook, *Quatre Petit Coins De Rien Du Tout*, is about what it means to belong and to have access. The friends of Little Square, all circles with varying textures, fit easily through the round school door but Little Square cannot join them. Following the principle of “where there is a will there’s a way,” they suggest Little Square alter himself (fold, turn, stretch, twist!) to fit through the door. At last, but not without some emotion, all finally realize it is the school that must change to fit everyone’s needs. As the book’s message is shared, children can manipulate the shapes, explore textures, and relate the illustrations to this very meaningful text.

Recommended ages: 3 years and up.

6-77957-00 \$219.00

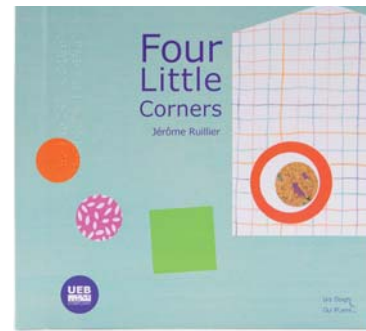

## Six Little Dots **UEB**

Six Little Dots is a texture-rich story book about braille fundamentals. Each 1/2-inch braille dot is a different and distinctive texture and color. The print/braille text introduces the braille dots as story characters who inhabit a braille cell, as they take their place in the braille cell. Features charming text and tactile illustrations.

Recommended ages: 3 years and up.

6-77954-00 \$139.00

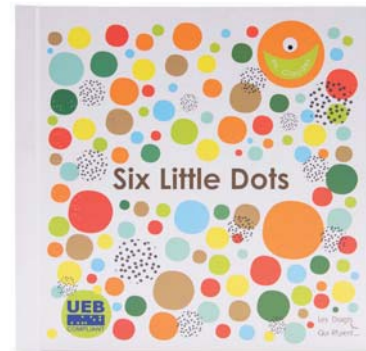

## Six Dots Game of Cards **N** **UEB**

42 colorful tactile cards belong to one of seven different texture “families” (names in print and braille on each card). Within each family are 6 unique cards, each with a single textured Dot in numbered positions modeled after the arrangement of dots in a braille cell. The goal is to collect all six Dot cards needed to form a complete family.

1-03569-00 \$99.00





**The Best for a Nest** **UEB**

This large print/braille storybook includes color illustrations on each page that depict the text. Includes storyboard and tactile manipulatives, making the reading experience fun and meaningful.

Recommended ages: 2 years and up

5-12301-01 \$109.00



**Reach For The Stars, Planning for the Future**

A first-of-its-kind guidebook about transitioning young children into preschool or kindergarten settings. Reach for the Stars creates inclusive, customized educational plans for young students.

**Large Print**  
7-08412-00 \$20.00

**Braille**  
5-08412-00 \$31.00



**Everyday Activities Calendar**

This idea-filled calendar suggests a fun preschool activity for each day of the year. This large print/braille calendar does not track any specific year, but can be used year after year.

Recommended ages: 3 years and up.

1-08121-00 \$171.00

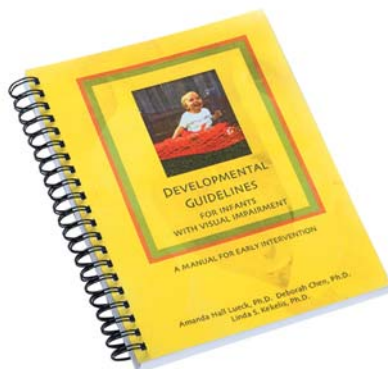

**Developmental Guidelines for Infants With Visual Impairments** **PARTS**

This guidebook is geared toward early intervention. It contains a wealth of information based on recent research and empirically-based observations about the development of infants with visual impairments. Professionals and caregivers will learn the sequence in which many skills develop.

**Note:** Developmental Guidelines was designed mainly for professionals who serve infants with visual impairments.

8-50701-00 \$95.00

## PATTER: Preschool Attainment Through Typical Everyday Routines

This curriculum and assessment tool is designed to facilitate skill development by preschool children who are visually impaired in the areas they are expected to master through involvement in typical household routines. Appropriate for use with children with additional impairments.

Recommended grade: Pre-K.

**Large Print**  
8-76001-00 \$89.00

**Braille**  
6-76001-00 \$79.00

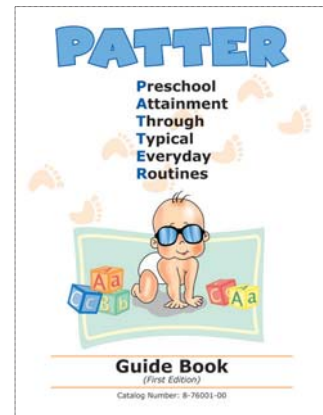

## Parents and Their Infants With Visual Impairments (PAIVI), 2nd Edition

This set of materials is designed to help parents and teachers of infants who are visually impaired become involved as primary members of the intervention team.

7-96149-00 \$51.00



## Parenting With a Visual Impairment: Advice for Raising Babies and Young Children

Advice from parents who completed an extensive written questionnaire and a 90-minute phone interview about how they accomplished parenting tasks using non-visual techniques. Each comes with audio CDs.

Recommended grades: Middle School and up.

**Large Print**  
8-00100-00 \$79.00

**Braille**  
6-00100-00 \$105.00



## Experiential Learning: Activities for Concept Development

Each section in this guidebook contains a brief overview of the skill or concept being addressed. The overview is followed by three suggested activities: a beginning, intermediate, and more advanced activity for each area. The service provider or parent must provide the toys and other materials to be used for each activity.

Recommended ages: Birth to 3 years, also has activities appropriate for older children working on the six developmental areas.

**Large Print/CD-ROM**  
8-50705-00 \$14.00



CD-ROM contains accessible formats of the guidebook.

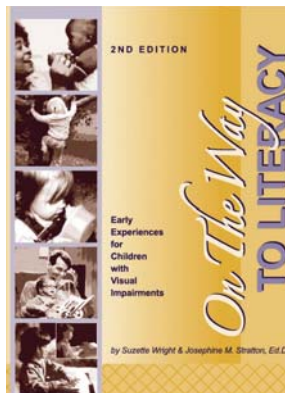

## On the way to Literacy: Early Experiences for Children who are Visually Impaired

This handbook and series of 18 storybooks contain vital information and activities to enhance the development of literacy in young children who are blind and visually impaired.

Recommended ages for storybooks: 2 1/2 to 5 years, except Gumdrop Tree.

## On The Way To Literacy Handbook, 2nd Edition

This handbook guides teachers and parents in supporting a young child's first steps towards literacy.

**Print**  
8-77520-00 \$60.00

**Braille**  
6-77520-00 \$210.00

## Storybooks With Real Objects and Textures

### Giggly-Wiggly, Snickety-Snick (Set III)

Words capture a range of tactile experiences. Real objects (not included) can be added to envelopes on the pages.

6-77502-05 \$74.00

### Something Special (Set I)

A young child searches for a lost possession; features objects affixed to the book pages.

6-77500-05 \$80.00

### That's Not My Bear (Set II)

A well-loved teddy bear is lost and cannot be replaced. The special bear and others offered by the family are represented by various furry shapes.

6-77501-01 \$71.00

### Geraldine's Blanket (Set II)

A girl's treasured blanket becomes worn and patched over time, but is never outgrown. Squares of fabric illustrate the fate of the blanket.

6-77501-02 \$99.00

## Storybooks Illustrated With Thermoforms

(Molded Plastic Shapes)

### Jennifer's Messes (Set I)

Familiar objects such as cereal, pretzels, and crayons illustrate the messes made by Jennifer.

6-77500-06 \$80.00

### Jellybean Jungle (Set III)

Scented stickers included. A counting rhyme about a magical jungle filled with jellybeans.

6-77502-01 \$92.00

### Gobs of Gum (Set I)

Scented stickers included.

A rhyming story about “big blobs, small gobs, and sticky icky strings of bubble gum.”

6-77500-08 \$59.00

### Roly-Poly Man (Set I)

A story about a young child who creates a “roly-poly” figure from pieces of clay.

6-77500-07 \$72.00

### Thingamajig (Set III)

Jamie is a collector of “thingamajigs” – coins, marbles, buttons, and other common objects. His treasures introduce the concept of grouping items and identifying missing items.

6-77502-04 \$65.00





## Special Storybook Lets Children Create a Story About Themselves

### Book About Me (Set I)

A “Me Book” for children to create. Comes with fill-in-the-blank sentences in braille and print, and space to add illustrations and text.

6-77500-10 \$30.00

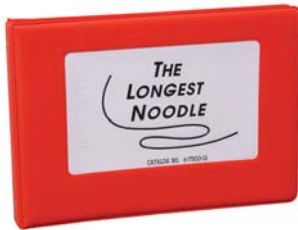

## Storybooks With Raised-Line Drawings

### The Longest Noodle (Set I)

A child finds the world’s longest noodle. Raised lines illustrate a shoelace, a jump rope, etc.

6-77500-01 \$37.00

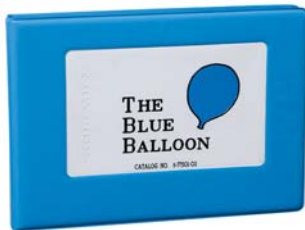

### The Blue Balloon (Set II)

A special balloon takes on extraordinary shapes and performs amazing feats. Illustrated with brightly colored, raised balloon shapes.

6-77501-03 \$59.00



### The Littlest Pumpkin

(see related puzzles page 31)

When the littlest pumpkin in the patch isn’t chosen to become a jack-o’-lantern, things seem very bleak – until a child discovers his hiding place!

6-77504-00 \$64.00



### That Terrible, Awful Day (Set I)

A young child’s popsicle gets smaller as everyone shares a taste.

6-77500-04 \$28.00

## The Caterpillar (Set I)

A visually impaired child makes an exciting discovery in her backyard. Has raised line drawings of a hand, foot, steps, and a fuzzy fabric caterpillar.

6-77500-02 \$37.00

## Silly Squiggles (Set I)

A worm like creature stretches, squeezes, and squirms into various shapes in this rhyming story.

6-77500-09 \$32.00

## Bumpy Rolls Away (Set I)

Bumpy the Ball rolls down a hill, down steps, onto a sidewalk, along an alley, and into a box.

6-77500-03 \$37.00

## The Gumdrop Tree (Set III)

Scented stickers included.

Tells the story of a tree that grows from a gumdrop! The raised-line drawings depict the growth of the tree.

6-77502-03 \$131.00





## On the Way to Literacy Book Sets

### Book Set I

Includes one print handbook and these ten storybooks: Something Special; Jennifer's Messes; Gobs of Gum; Roly-Poly Man; The Longest Noodle; That Terrible, Awful Day; The Caterpillar; Bumpy Rolls Away; Silly Squiggles; and Book About Me.

**6-77500-00 \$552.00**

### Book Set II

Includes these three storybooks: That's Not My Bear, Geraldine's Blanket, and The Blue Balloon.

**6-77501-00 \$229.00**

### Book Set III

Includes these four storybooks: Giggly-Wiggly, Snickety-Snick; Jellybean Jungle; Thingamajig; and The Gumdrop Tree.

**6-77502-00 \$362.00**

## APH SoundPage

The APH SoundPage allows readers to create their own sound effects and recordings. Holds up to three 8-second digital recording/playback devices (two included in basic set), the page can be clipped into the 3-ring binder of any OTWL storybook.

**6-77505-00 \$54.00**



## Alphabet Scramble Storybook

A read-aloud storybook promoting emergent and early literacy skills. The rhyming story tells of a “family” of alphabet letters as each sets out to explore the page. As each letter takes a turn crossing the page, which is shown as a line of repeating letters, the child can track along the line of braille, gaining tactile braille reading skills.

5-01199-00 \$62.00

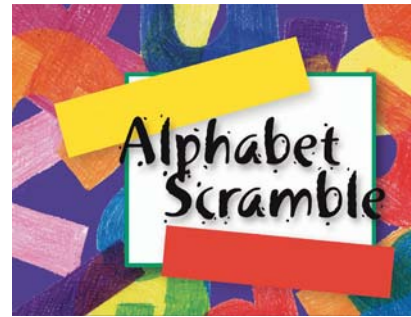

## Pumpkin Puzzles

APH offers two pumpkin puzzles related to The Littlest Pumpkin storybook. These puzzles, sold as a set, depict the Littlest Pumpkin and another jack-o'-lantern face. Orange and black foam puzzle pieces are reversible.

1-08835-01 \$29.00



## Important Icon Legend



### CVI Icon

Products with this icon may be appropriate for learners diagnosed with CVI. Comprehensive assessment should determine which products are best matched to your learner’s needs.



### Safety Warnings Icon

Please note and follow the small parts choking hazard and other warnings indicated for certain APH products.



### UEB Icon

Products with this icon are transcribed in Unified English Braille (UEB).



### Replacement and Optional Parts Available Icon

Products with available replacement parts are marked with this icon. Refer to the Replacement Parts Catalog on our website.



### Downloadable Manuals

Most APH products have manuals available for immediate, free-of-charge downloading for printing or embossing as needed. Please visit [aph.org](http://aph.org) to download a manual.



### New Product



### Revised Product

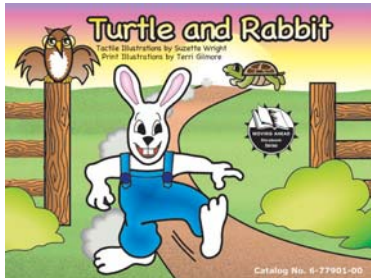
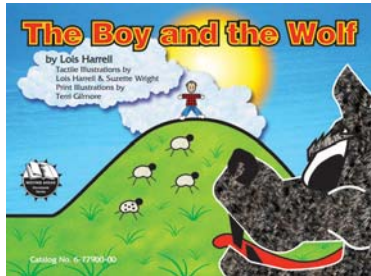
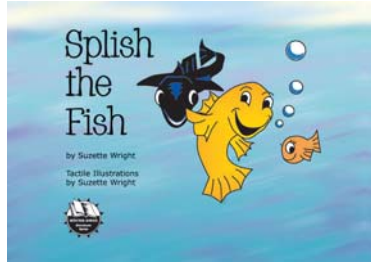

## Moving Ahead Series

A follow-up to APH's On the Way to Literacy Series, Moving Ahead storybooks introduce symbolic representation, more complex illustrations, and an increased emphasis on text. Each storybook includes a large print Reader's Guide (braille edition available as a free download) that contains general information, tips on using the storybook, and additional resources. Also included are braille words on customer-applied labels.

### Going on a Bear Hunt

A tactile line guides on a bear hunt. In the process of hunting for a bear, the reader follows a tactile line through the story.

Recommended grades: Pre-K to 3rd.

6-77903-00 \$77.00

### Splish the Fish

Tactually search for Splish and help him find his way back to his friends.

Recommended grades: Pre-K to Kindergarten.

6-77902-00 \$79.00

### The Boy and the Wolf

Tactually search the page for characters, count and compare like and different pairs of sheep, and notice differing orientations and other features.

Recommended grades: Pre-K to 2nd.

6-77900-00 \$83.00

### Turtle and Rabbit

Tactually follow the progress of the race between the tortoise and the hare.

Recommended grades: Pre-K to 2nd.

6-77901-00 \$85.00

**VIPS@Home:  
Parent Empowerment Program** UEB CVI

This three-module program developed from a partnership between APH and Visually Impaired Preschool Services (VIPS) offers courses for parents that can be studied at home. These materials offer opportunities for connecting with professionals and other parents for support.

Recommended ages: Birth to 5 years.

Each course includes a large print Course Book and CD-ROM with accessible files including a .brf in UEB and a presentation tool.

VIPS@Home is available with Quota funds.



**Emergent Literacy**

Story time comes to life! Program teaches parents how to become comfortable and vibrant storytellers.

8-00076-00 \$19.00



**Power at Your Fingertips**

Provides a concise and family-friendly introduction to braille. Parents can begin to experience the joy of learning braille without the frustration of enormous textbooks, and will learn how to bring braille literacy into their everyday routines and discover numerous resources for child-ready braille materials.

8-00075-00 \$19.00

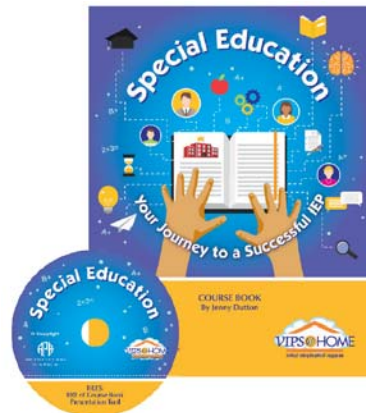

**Special Education: Your Journey to a Successful IEP**

Helps demystify conferences and paperwork, and puts parents at ease during the school years ahead.

8-00078-00 \$19.00



## Sensory Learning Kit (SLK)

This Kit contains an extensive set of sensory items and written materials that help learners increase their curiosity and develop specific skills. Tools in this Kit may be used to help create daily schedules, lesson plans, and alternative assessments for play or functional routines.

**1-08611-00** \$463.00



## Select Switch

Designed for use in educational and daily living applications, Select Switch is useful for individuals with severe motor disabilities and cognitive impairments. Various function control features enable individuals to communicate and control battery operated appliances, toys, and devices. Requires 4 AAA batteries (not included).

**1-08617-00** \$125.00



## The Joy Player

This easy-to-load, switch-activated music player allows individuals who are developing fine motor skills, have limited mobility, or cognitive disability (in addition to a visual impairment) to access music and audio books. Designed to use with the personal music player routine in APH's SLK.

Recommended ages: 3 years and up.

**1-07089-00** \$349.00 + shipping

## Fine Motor Development Materials: Twist, Turn, and Learn

Helps young children with visual and multiple disabilities develop and enhance fine motor skills. This kit assists in developing grasping, pincer grasp, wrist rotation, palmar grasp, and more. Primarily for professionals.

Recommended ages: Birth to 36 months.

1-08420-00 \$608.00



## Effective Use of Objects: A Process Centered Intervention

Helps learners with multiple disabilities develop task-oriented behavior that is self-regulating. Focuses on the kinds of problem-solving skills that encourage the functional use of objects. For parents and professionals.

Recommended ages: 2 to 7 years.

7-35500-00 \$115.00

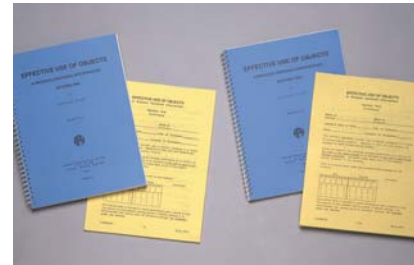

## HANDS ON: Functional Activities for Visually Impaired Preschoolers

Helps children develop skills such as concentration, hand and visual coordination, ability to complete a cycle of activity, and socialization skills. Also helps develop a sense of order and a positive self-image. For parents and professionals.

Recommended ages: 3 to 6 years.

1-03260-00 \$280.00



## Tactile Treasures: Math and Language Concepts for Young Children With Visual Impairments

An informal assessment and teaching tool for use with children to develop an early understanding of basic concepts and vocabulary. By pairing tactile graphics of thermoformed real objects with included descriptive scripts/stories, over 90 concepts can be introduced and reinforced.

**Note:** Large print guidebook (with CD-ROM) included, braille guidebook available separately.

Recommended ages: 3 years and up.

1-08842-01 \$506.00



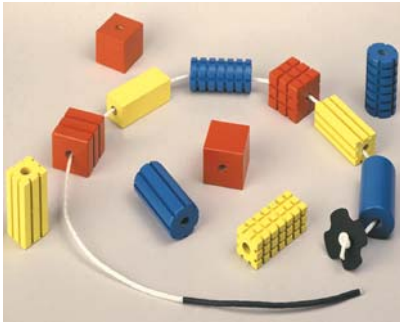

## Giant Textured Beads

Introduces a variety of concepts, including shape, color, and texture. Also assists in the development of muscular and eye-hand coordination. Shapes have three textures. Bead stringer included.

**Warning:** Strangulation Hazard - Adults should be aware of the strangulation hazards associated with cords and take precautions through supervision and instruction to ensure children do not become entangled.

Recommended ages: 3 to 6 years.

1-03780-00 \$71.00



## Giant Textured Beads With Pattern Matching Cards

This kit is designed with preschool through early elementary students in mind. Pattern Matching Cards reinforce the tactile continuum from real objects (most basic level) to raised-line graphics (most advanced level). Students in higher grades will be challenged by the increasing difficulty posed by the “Platform” and “3-D View” matching cards.

**Warning:** Strangulation Hazard - Adults should be aware of the strangulation hazards associated with cords and take precautions through supervision and instruction to ensure children do not become entangled.

1-03778-00 \$182.00

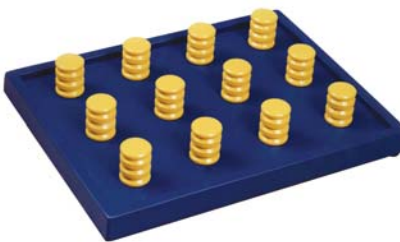

## Textured Pegs

Helps develop fine motor skills, manual dexterity, and grasp/release skills, reinforcing concepts of direction and position.

Recommended ages: 1 to 6 years.

1-08930-00 \$45.00



## Textured Matching Blocks

Encourages recognition of textures, identification by name, and tactual matching, while reinforcing directional and positional concepts.

Recommended ages: 3 to 6 years.

1-08950-00 \$72.00



## Puzzle Form Board Kit **PARTS**

Supplementary aid for teaching basic concepts, such as shape, texture, color, size, and matching.

Recommended ages: 3 years and up.

1-03721-00 \$130.00

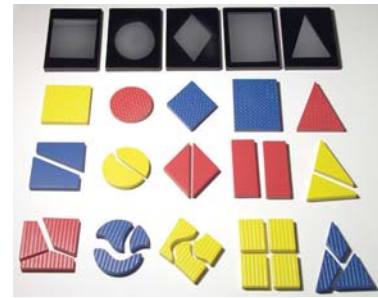

## Peg Kit **PARTS**

Helps children develop skills in manipulation, number and language concepts, and color, size, and tactual discrimination

Recommended ages: 3 to 8 years.

1-03420-00 \$56.00



## Sound Matching Board I

Develops fine motor skills and auditory matching and discrimination, with the capability of introducing sequential order.

Recommended ages: 3 years and up.

1-08710-00 \$80.00



## Sound Matching Board II

Helps develop concepts of a series, directions, positions, matching, and discrimination. Eight shakers with four different sounds.

Recommended ages: 3 years and up.

1-08720-00 \$59.00





## Sensory Cylinder Set

Develops skills in manipulation, number and language concepts, and tactual, color, and weight discrimination.

Recommended ages: 3 years and up.

1-03670-00 \$87.00



## Small, Medium, and Large Circles, Set I

Introduces the concept of fine size discrimination. Frame contains three recessed nests for holding six foam circles of various sizes.

Recommended ages: 1 to 3 years.

1-08590-00 \$21.00



## Small, Medium, and Large Circles, Set II

Facilitates perception of three dimensions, while strengthening manipulative, matching, and discrimination skills. Base has three pegs for sorting circles. As circle diameter increases, thickness decreases.

Recommended ages: 3 to 6 years.

1-08600-00 \$58.00



## Shape Board CVI

Proportional shapes contrast brightly against the yellow pegboard and aid in understanding up, down, right, and left. Consists of 25 geometric figures and a board with three columns of five pegs.

Recommended ages: 4 years and up.

1-03710-01 \$96.00





## Tangle Toy and Tangle

### Book Kit

With its infinite knot shapes and variety of colors and textures, the Tangle Toy® can be used to encourage a child to explore, move, and play. Tangle Book activities and games help both children who are sighted and children who are visually impaired refine motor skills, color discrimination, and tactile discrimination.

1-08750-00 \$63.00



## Spangle Tangle:

### Play and Explore

Provides opportunities for learners to improve visual and tactile attention, communication, and creativity. Through specially designed activities, the learner develops motor, problem-solving, cognitive, self-care, social, and pre-braille skills.

Recommended ages: 5 years and up.

1-08755-00 \$131.00



## Sound Adapted Tangle Ball Kit

This ball is great for educational play and doubles as a teething toy. Develops hand-eye coordination, sound localization skills, fine motor skills, and interaction with others. Made of safe, soft plastic material.

**Note:** Interior ball can be removed if desired. Some assembly required.

Recommended ages: 6 months and up, with adult supervision.

1-08111-00 \$44.00



## Jumbo Work/Play Tray

The Jumbo Work/Play Tray provides learners who have visual impairments and/or other significant challenges with a tool with which they can play, explore, and learn independently. The large size (24 x 24 inches) allows ample space for active learning and prevents toys from rolling out of reach. A yellow liner accompanies the tray for additional color contrast.

1-03764-00 \$69.00



Balls not included.

800.223.1839



## Work-Play Trays CVI

Durable trays hold objects which might roll out of reach. Trays provide enclosed work space for sorting, matching, classifying, counting. Two sizes and colors available.

### Small Work-Play Tray

17x11 3/4 inches

**Black 1-03751-00** \$26.00

**Yellow 1-03660-00** \$26.00

### Large Work-Play Tray

21 1/4x13 1/4 inches

**Black 1-03761-00** \$25.00

**Yellow 1-03740-00** \$26.00

### Dividers (4-pk)

for Small Work-Play Tray

**1-03770-00** \$36.00



## VIPS Video Library

This video library from Visually Impaired Preschool Services (VIPS) is a series of essential videos for parents and caregivers of young children who are visually impaired and blind.

This library offers practical and proven techniques that foster their development.

### Seeing Things in a New Way

**1-30024-DVD** \$53.00

### Moving Through the World

**1-30030-DVD** \$57.00

### Learning About the World

**1-30025-DVD** \$57.00

### Hands on Experience

**1-30031-DVD** \$57.00

### Becoming A “Can-Do” Kid

**1-30026-DVD** \$57.00

### Power at Your Fingertips

**1-30033-DVD** \$85.00

### Making Friends

**1-30027-DVD** \$57.00

### Full of Hope

**1-30034-DVD** \$64.00

### Going Places

**1-30028-DVD** \$57.00

### Through Their Eyes

**1-30029-DVD** \$53.00

### Growing My Way

Part 1: (3–18 Months)

3-Video Series

**1-30035-DVD** \$160.00

### Growing My Way

Part 2: (24–36 Months)

3-Video Series

**1-30036-DVD** \$171.00

### Successfully Adapting the Preschool Environment

**1-30032-DVD** \$57.00

## Every Child Can, VIPS Video **N PARTS**

A new addition to the VIPS Video Library Series, this video attempts to demystify the Expanded Core Curriculum (ECC) for parents of young children who are visually impaired, and for their general education teachers who may have limited expertise and experience teaching children with vision loss. English and Spanish versions are available in DVD and optional USB formats, with both audio descriptions and closed captioning. This product is not available for purchase with quota funds.

### English

1-30037-DVD \$50.00

### Spanish

1-30038-DVD \$50.00



## Rolling Into Place™

As the hook-and-loop material ball is rolled to its final “surprise” destination, important hand skills and basic directional concepts are learned and reinforced. This interactive storybook’s simultaneous visual, tactile, and auditory feedback help the child attend to the path traveled by the ball. Also included are an assortment of interactive hook-and-loop material face pieces and suggested activities.

1-08450-00 \$96.00

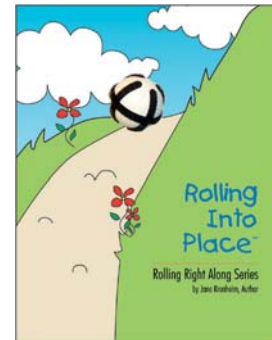

## Rolling Right Along Construction Kit™

This Kit allows teachers and parents to construct books similar to APH’s Rolling Into Place. Using provided accordion-folded panels, hook-and-loop material pathways, and accessory items, self-designed books can be tailored to the child’s interests and needs.

1-08451-00 \$72.00



## Sticky Dots Adhesive™

Make any lightweight objects self-adhesive! Use to create tactile books, worksheets, adapted game boards, etc. These sheets allow you to transfer the dots to a wide range of materials, (felt, craft foam, textured paper, etc.). Package includes eight 8 1/2 x 11 inch sheets in a tear-off pad.

1-08452-00 \$9.00

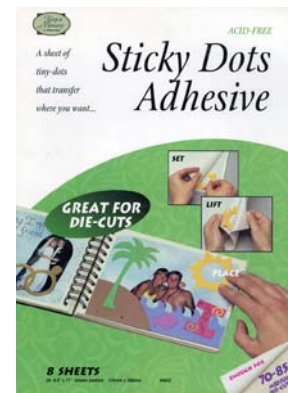

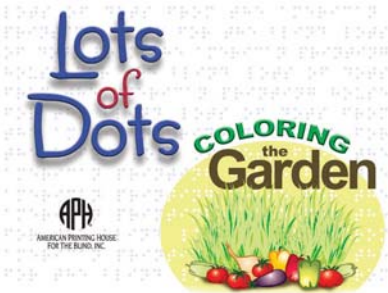
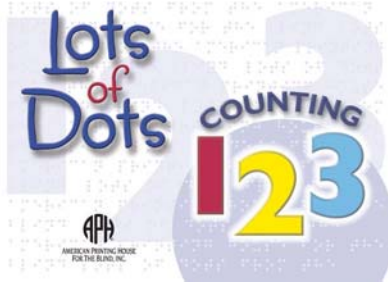
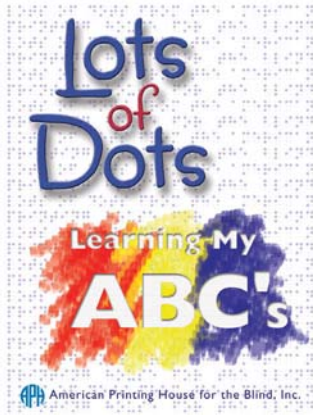

## Lots of Dots Coloring Book Series

An exciting set of three raised-line coloring books designed for future large print and braille readers. The books are designed for sequential use; children develop character recognition, pre-literacy, and pre-math skills, and eventually picture building and daily living skills.

Accompanying each book are suggested enrichment exercises for each letter, number, or word, allowing a child to fully associate the print letter, the braille, the tactile graphic, and the object.

Recommended grades: Pre-K and up.

### Learning My ABC's

Facilitates braille character recognition through repetitive activities. Attached to the inside front cover is a plastic stencil of the jumbo cell that can be folded over the blank pages, allowing the student to practice the braille cell for that letter.

1-10000-00 \$69.00

### Counting 1 2 3

Presents numbers 0–30 and then integers of 10 up to 90. Attached to the inside front cover is a plastic stencil of 3 large braille cells. This can be folded over the blank pages, allowing the child to practice the braille cell for the number by tracing or by using the accompanying foam braille chips. This book uses uncontracted braille.

1-10001-00 \$81.00

### Coloring the Garden

Presents a variety of fruits, vegetables, and herbs, and introduces picture building. Beginning with an empty garden; each page adds a new feature (clouds, rain, seeds, and plants). Once the garden has grown, a new garden item is introduced for the child to color. Uncontracted and contracted braille are used.

1-10002-00 \$66.00





## Word PlayHouse

Helps students focus on phonics, spelling, and phonemic awareness. Use Word PlayHouse to teach beginning phonics and reading skills including letter recognition, braille code recognition, decoding, vocabulary, and spelling skills.

Recommended ages: 5 to 8 years

**1-03562-00** \$342.00



## Braille Contraction Cards

These large print/braille flashcards are for practicing the Literacy Braille contractions.

Includes 282 cards, 78 blank cards, 30 indexing cards with tabs, and a storage box.

Recommended ages: 6 years and up.

**1-03561-01** \$38.00



## Expanded Dolch Word Cards

These large print/braille flashcards can be used for reading practice or an informal assessment of a student's ability to read words in contracted braille and spell words in uncontracted braille. Picture word cards contain a picture corresponding to the word.

Recommended ages: 5 years and up.

**1-03560-01** \$42.00

## Wilson Reading System® (WRS) and Instructional Materials

A complete curriculum for teaching decoding and encoding (spelling), beginning with phoneme segmentation. WRS provides an organized, sequential system with extensive controlled text to help teachers implement a multi-sensory structured language program.

This system specifically addresses the learning style of students with a language-based learning disability; however, it is beneficial to any student lacking basic reading and spelling skills.

The Wilson Reading System is authored by Barbara A. Wilson and published by Wilson Language Training Corporation. Permission has been granted to APH to publish the braille and large print versions. For more information and professional

development opportunities on the use of the program and certification, please visit: [wilsonlanguage.com](http://wilsonlanguage.com).

Teacher Manuals may be ordered from the Wilson Language Training website.

Recommended grades: 2 and up.

**Note:** WRS Instructional Materials are needed to work with the WRS Large Print and Braille Student Kits.



### WRS, Student Reader Kit, Braille

Student Reader One, Supplemental Worksheets One, Modified Workbooks 1A and 1B, Teacher's Brochure, and WADE Sheets

**6-79501-SK** \$306.00

Student Reader Two, Supplemental Worksheets Two, Modified Workbooks 2A and 2B, and Teacher's Brochure

**6-79501-SK2** \$259.00

Student Reader Three, Supplemental Worksheets Three, Modified Workbooks 3A and 3B, and Teacher's Brochure

**6-79501-SK3** \$263.00



### WRS, Student Reader Kit, Large Print

Student Reader One and Workbooks 1A and 1B

**8-79501-SK1** \$41.00

Student Reader Two and Workbooks 2A and 2B

**8-79501-SK2** \$37.00

Student Reader Three and Workbooks 3A and 3B

**8-79501-SK3** \$37.00



### WRS Instructional Materials

**Card Sets w/Carry Case**  
**6-79505-00** \$164.00

**Print/Braille Magnetic Tiles and Journal**  
**6-79506-00** \$67.00





**Tactile Editing Marks Kit** PARTS UEB

The use of tactile editing marks provides beginning writers with a concrete way to indicate changes on their braille drafts as they revise and edit short pieces, enabling students to write final correct copies of their work independently.

Recommended ages: 5 years and up.

1-08896-00 \$65.00



**All Aboard! The Sight Word Activity Express** UEB CVI

This set of interactive and versatile magnetic print/braille labels can be used for instruction and assessment of a student’s recognition of sight (high frequency) words — the most commonly used words in the English language. The list of 220 words, plus 95 nouns or “picture words,” was developed by Edward W. Dolch and is referred to as the “Dolch® Basic Sight Word List.”

1-03558-00 \$321.00



**All Aboard! Magnetic/Dry Erase Board** UEB

Use for activities involving magnetic-backed pieces or activities requiring dry erase markers. The working surface of the board measures 13 1/2 x 10 11/16 inches and is affixed to a red rigid vinyl that provides a visual boarder.

Recommended ages: All.

1-03559-00 \$27.00





# Mathematics Section Index

Abacus Basic Competency: A Counting Method .....	62	One-Foot Braille Rulers .....	61
Abacus Made Easy, The .....	63	Orion TI-84 Plus .....	53
Abacuses .....	63	Place Value Setter <b>N</b> .....	48
Addition and Subtraction Table Kit .....	56	Practice2Master Fractions .....	49
Advanced Desktop Stick-On Number Lines .....	53	Protractors .....	58
Analog Clock Model .....	64	Quick Pick Series .....	60
AnimalWatch Vi Suite .....	49	Slapstack Math .....	51
Braille/Large Print Yardstick .....	61	StackUps .....	56
Brannan Cubarithm Slate and Cubes .....	59	Tactile Compass for Math and Art .....	55
Clock Face Sheets in Braille .....	64	Tactile Algebra Tiles .....	49
Consumable Hundreds Chart .....	56	Tactile Tangrams .....	50
Consumable Number Lines .....	52	Transparent CCTV Rulers .....	61
Desktop Stick-On Number Lines .....	52	Textured Sorting Circles and Shapes .....	55
Draw2Measure Protractor .....	50	UEB Math Tutorial <b>N</b> .....	51
EZeeCOUNT Abacus .....	53	Using the Cranmer Abacus .....	62
Flexible Rulers (Braille/Large Print) .....	61	Venn Diagram Template Kit .....	57
FOCUS in Mathematics Kit, 2nd Ed .....	55		
Fractional Parts of Wholes Set .....	58	<b>Mathematics Related Products</b>	
Geometric Forms .....	57	Bold-Line Tactile Graph Sheets .....	119
Geometro .....	54	Braille Transcriber's Kit: Math .....	112
Geometry Tactile Graphics Kit .....	57	Calendar Kits .....	99
Graphic Aid for Mathematics .....	58	Card Chart Kit .....	99
Hands-On Experience w/Cranmer Abacus Video .....	62	EZ Track Financial Record Keeper .....	158
Large Print/Braille Toss-Away Ruler .....	60	Feel 'n Peel Stickers .....	94
MathBuilders Kits .....	52	Graph Paper .....	118–119
Math Drill Cards .....	59	Lots of Dots Series .....	42
Math Flash Software .....	50	Money Handling & Budgeting .....	157
Math Robot .....	48	Money Talks Software .....	157
Meterstick (Braille) .....	61	Nemeth Code for Mathematics and Science .....	168
Multiplication & Division Table Kit .....	56	Score Card Set .....	161
Nemeth Code Reference Sheet .....	59	Tactile Demonstration Thermometer .....	67
Nemeth Tutorial .....	51	Tactile Treasures .....	35
Number Line Device .....	53		

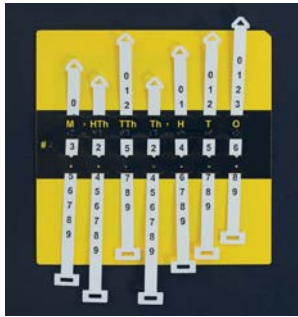

## Place Value Setter

Students will gain knowledge of conceptual models of place value and then connect that knowledge with written representations. With its refreshable and concrete display, the Place Value Setter gives students who are blind and visually impaired, as well as their teachers, a prompt way to represent numbers using written digits.

Designed for elementary school students, especially 1st to 3rd graders, this tool is particularly useful for the following groups:

- students with blindness and low vision who need to practice quick and simple place value setting
- teachers or teaching assistants of students with visual impairments who want to set up place value problems quickly so that, in inclusive settings, their students can follow classroom instructions and participate in real time classroom activities
- for non-braille readers, such as parents and sighted students, to work together with students with visual impairments
- for students who benefit from hands-on learning to get a concrete learning experience

1-08284-00 \$109.00

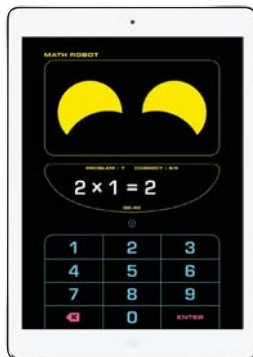

## Math Robot (for iPad)

APH's Math Robot™ has a smart “know-it-all” math robot character that provides fun drills and practices for simple math problems. The app is both self-voicing and accessible with Apple's VoiceOver. A low vision mode adds extra contrast.

Recommended ages: 6 years and up.

### Non-Quota Order

Available from the App Store: <https://itunes.apple.com/app/math-robot/id704570512>

\$4.99

### Quota Order

**Note:** Find detailed software purchasing instructions in the “How to Order” section page 181.

D-30000-APL \$4.99

## Practice2Master Fractions

A fully accessible app that every elementary school math teacher should have in their teaching toolbox - Practice2Master Fractions helps students become proficient in fraction calculations. It supplements teachers' instructions by providing students with an unlimited number of problems to practice. App works with devices running iOS 9 or later, and is compatible with VoiceOver.

Recommended ages: 9 years and up.

Available from the App Store: <https://itunes.apple.com/us/app/practice2master-fractions/id1257764758?mt=8>

**D-30030-AP FREE**



## AnimalWatch Vi Suite (for iPad)

The AnimalWatch Vi Suite includes an app available from the App Store with accompanying braille and print materials. The app and materials are available for free! Students at the pre-algebra level (grades 5–7) will build their math word problem solving skills while learning about endangered and invasive species such as the black rhino, cheetah, gray wolf, and white shark.

Recommended grades: 5th to 7th (math level).

Available from the App Store: <https://itunes.apple.com/app/animalwatch-vi-suite/id1051014170?mt=8>

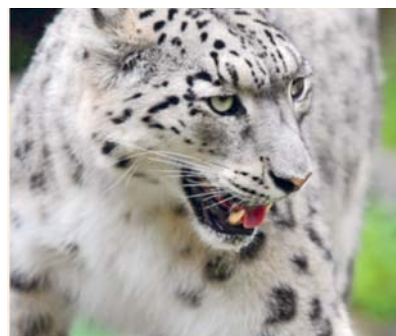

## Tactile Algebra Tiles

Tactile Algebra Tiles is an accessible version of traditional algebra tiles, specifically designed for students who are blind and visually impaired. It includes magnetic tiles that the students can manipulate on a steel board, and uses tactile symbols to help students differentiate between tiles. Colors are chosen with consideration for the needs of students who have low vision. This product is consistent with traditional algebra tiles used by sighted students, allowing students who are visually impaired to work together with their classmates in inclusive classrooms.

**1-08410-00 \$159.00**

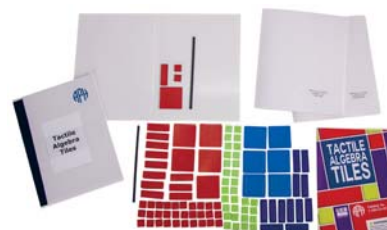



## Draw2Measure Protractor (for iOS devices)

This app is designed for students who are blind and visually impaired, and can be used by sighted students too! It gives students an alternative way to measure angles, thus meeting students' diverse needs in math and science classrooms. Works with devices running iOS 8 or later.

Watch a short video:

<https://www.youtube.com/watch?v=D77pBfjCmMI> to see the Draw2Measure™ Protractor app in action!

Available from the App Store: <https://itunes.apple.com/us/app/draw2measure-protractor/id1097557700?mt=8>

**D-30023-AP** FREE



## Math Flash Software

This software helps elementary students sharpen math skills with talking electronic flash cards.

This self-voicing program uses the computer's sound card to communicate instructions, drills, practice sessions, and games.

Requires a PC running Windows® 7 or later.

See page 143 for Google Action and Alexa Skill versions.

Recommended ages: 6 years and up.

**CD-ROM**

**D-19910-01** \$24.00

**Digital Download**

**D-19910-ED** \$24.00



## Tactile Tangrams

The materials and activities presented in APH's Tactile Tangrams make this puzzle accessible to students and adults with visual impairments and blindness. The use of tangram puzzles encourages the development and reinforcement of many educational and recreational skills, including spatial reasoning, shape recognition, size comparison, pattern replication, and independent problem solving.

**1-08439-00** \$195.00

## Nemeth Tutorial

APH's online Nemeth Tutorial consists of over 50 lessons within 11 chapters. It shows teachers and students the rules of the Nemeth Braille code and provides exercises to help teach it.

Recommended ages: 5 years and up.

Available from APH: [tech.aph.org/nemeth](http://tech.aph.org/nemeth)

FREE

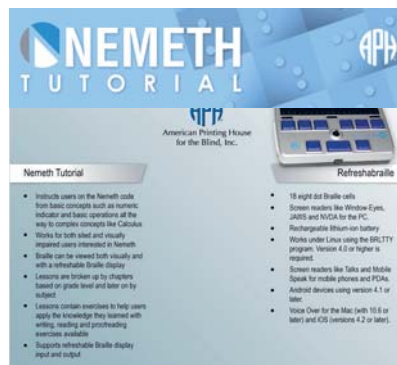

## UEB Math Tutorial

APH's UEB Math Tutorial contains over fifty lessons broken into 10 chapters that cover the rules of UEB Mathematics. This web-based program runs on any modern computer platform, works well with refreshable braille displays, and it's available free-of-charge!

### Each lesson contains four sections

- Explanation
- Reading Exercises
- Writing Exercises
- Proofreading Exercises

### Sighted User Features

- Braille displayed with a Unicode font
- Braille can be entered with a standard QWERTY keyboard using six-key entry
- Mathematical expressions are displayed using MathML

### Blind User Features:

- Works with existing screen readers on all major platforms
- Supports input and output with Braille Displays

Recommended ages: 5 years and up.

D-30032-ED FREE

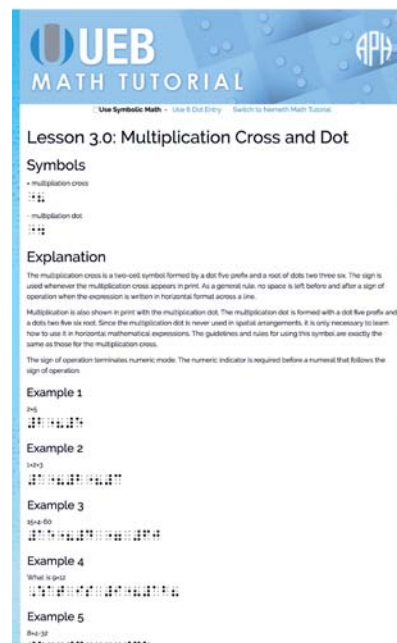

## Slapstack Math (for iOS devices)

Slapstack Math™ is fully accessible for all users. The goal is to collect the most points by pulling in the most cards. Two to eight players can play on the iPad®, or two to four players on the iPhone®.

Recommended ages: 7 years and up.

Available from the App Store: <https://itunes.apple.com/us/app/slapstack-math/id1209184917?mt=8>

D-30025-AP FREE

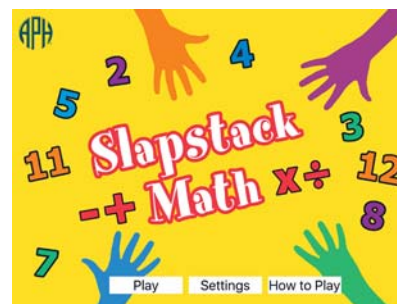



## MathBuilders

This supplementary math program is separated into eight units by content standards and grade level. This allows the teacher to focus on specific standards or provide remedial material for individual students.

Recommended ages: 5 years and up.

### Large Print Kit

**Unit 1**  
**Matching, Sorting,**  
**and Patterning**  
 7-03560-00 \$271.00

**Unit 7**  
**Fractions, Mixed**  
**Numbers, and Decimals**  
 7-03564-00 \$265.00

**Unit 5**  
**Measurement**  
**and Estimation**  
 7-03562-00 \$249.00

**Unit 8**  
**Data Collection,**  
**Graphing, and**  
**Probability/Statistics**  
 7-03565-00 \$175.00

**Unit 6**  
**Geometry**  
 7-03563-00 \$288.00

## Consumable Number Lines

Reinforces beginning number concepts such as counting, sequencing, number recognition, number relationships, addition, and subtraction. Use the blank number lines to provide a concrete representation when introducing fractions, decimals, or negative numbers.

Recommended ages: 6 years and up.



**Large Print**  
 1-03012-00 \$14.00

**Braille/Tactile**  
 1-03013-00 \$27.00

## Desktop Stick-On Number Lines

Visually and/or tactually demonstrate basic number concepts. Number Lines are reusable up to five times. The adhesive will not permanently stick to surfaces. Sold in (5-pk).

Recommended ages: 6 years and up.



**Large Print/Braille**  
 1-03481-00 \$22.00

## Advanced Desktop Stick-On Number Lines

Visually and/or tactually demonstrate the basic concepts of negative numbers: counting, sequencing, number relationships, addition, and subtraction. Supports Common Core State Standards, Number Sense, Grades 6 & 7.

Recommended ages: 11 years and up.

**Large Print/Braille** (5-pk)

**1-03482-00** \$30.00



## Number Line Device

The number line is a basic tool for teaching number concepts, number sequence, counting, addition, subtraction, multiplication, division, rounding, estimating whole numbers, common fractions, and decimals.

Recommended ages: 5 years and up

**1-03480-01** \$194.00

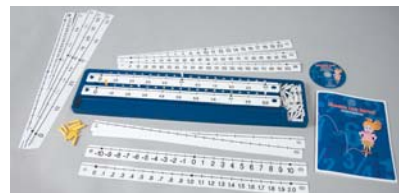

## EZeeCOUNT Abacus

This abacus consists of a 10 x 10 grid of flat beads. The beads can be flipped and distinguished by color and/or texture. Each row of beads slides along an elastic band from left to right. The reverse side is a dry-erase board.

Recommended ages: 5 years and up.

**1-03185-00** \$70.00



## Orion TI-84 Plus Talking Graphing Calculator

The Orion TI-84 Plus™ Talking Graphing Calculator is a modified TI-84 Plus with a small attachment that adds accessibility and additional controls. APH partnered with Orbit Research® and Texas Instruments® to make this powerful calculator accessible.

Recommended for: Algebra 1&2, Geometry, Statistics/AP Statistics, Pre-Calculus, Calculus/AP Calculus, Trigonometry, Physics, and College Math.

Not Recommended for students below grade 6.

**1-07340-00** \$599.00





Large Set

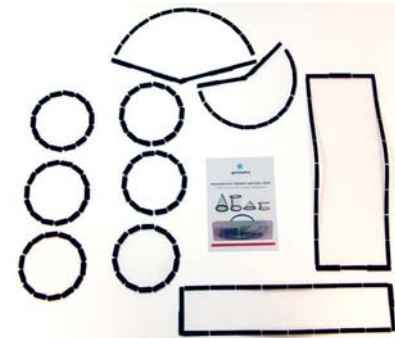
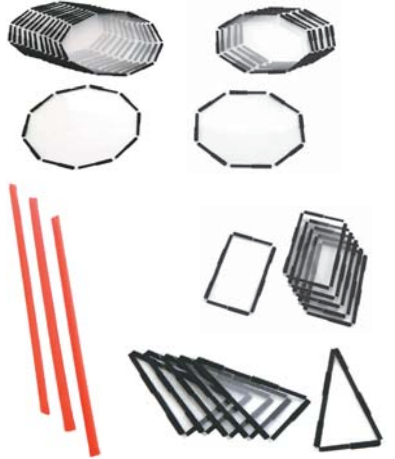

## Geometro Sets

Provides hands-on experience with manipulatives that aid in teaching 3-D geometry. Geometro pieces use hook-and-loop material to adhere to each other and are easy to handle, sturdy, and safe.

### Mini Set

1-03022-00 \$102.00

### Large Set

1-03024-00 \$319.00

### Medium Set

1-03023-00 \$133.00

## Geometro Shapes

Optional sets can be purchased in addition to the Geometro kits. These shapes can be combined with the main Geometro kits to create additional 3-D solids.

### Decagons (12-pk)

1-03025-00 \$223.00

### Rectangles (6-pk)

1-03028-00 \$48.00

### Octagons (6-pk)

1-03026-00 \$115.00

### Isosceles Triangles (6-pk)

1-03029-00 \$39.00

### Hook Material Rods (3-pk)

1-03027-00 \$35.00

## Geometro Cylinder and Cone

These materials provide students with flat plastic shapes (six circles, two rectangles, and two circle sectors) that can be readily joined to form two cylinders and two cones.

1-03030-00 \$131.00

## Student Workbook Kit for Geometro

This Kit is designed for students in the elementary grades, and revolves around three kinds of 3-D and 2-D tasks. To learn more about Geometro, visit: [www.geometro.net](http://www.geometro.net)

1-03021-00 \$358.00



## Textured Sorting Circles and Shapes

These assorted shapes are provided in a variety of textures, sizes, and colors. The accompanying sorting circles are also provided in a variety of colors and textures, and can be used to create Venn diagrams.

1-08834-00 \$144.00



## Tactile Compass for Math and Art

This assistive tool enables students to draw tactile circles up to 6 inches in diameter and includes tactile markings in inches and centimeters. Includes two different spur wheels to draw both single-line and double-line circles. Used in combination with braille paper or plastic film and a rubber mat (not included with this product).

Recommended ages: 7 years and up.

1-08894-00 \$62.00



## FOCUS in Mathematics Kit, Second Edition

Objectives are aligned to National Council of Teachers of Mathematics Curriculum Focal Points.

Materials include hundreds of manipulative items, designed to be easily handled and offer tactile and visual contrast. Teacher materials include a Teacher's Guide, reusable student worksheets, and printable assessment checklists included on the CD.

Recommended grades: Pre-K to 1st.

1-08280-01 \$727.00

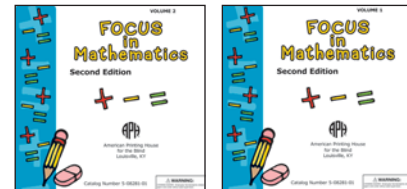
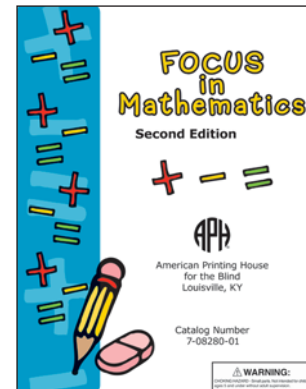



## StackUps: Spatial Reasoning Using Cubes and Isometric Drawings

Encourages students using 2-D and 3-D shapes to: recognize, name, build, draw, compare, and sort; describe attributes and parts, and; investigate and predict the results of putting together and taking apart.

Recommended ages: 10 years and up.

1-08960-00 \$383.00



## Addition and Subtraction Table

Large print/braille tool designed to reinforce the basic addition and subtraction facts. Includes 10 printed/embossed charts and a print guidebook.

5-82699-00 \$32.00



## Multiplication/Division Table

The chart is printed/embossed on white index stock and is 3-hole punched. Alternating rows are highlighted to help low vision students easily track numbers. Includes 10 charts (grids) and a print guidebook.

5-82700-01 \$19.50

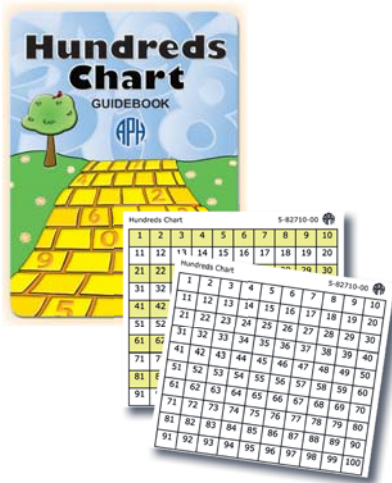

## Consumable Hundreds Chart

This graphic organizer for the numbers 1–100 helps learners develop the skills they need to become flexible and fluent problem solvers and meet the requirements of many state standards as well as the Common Core State Standards.

The chart is printed/embossed on white index stock paper. Alternating rows are highlighted to help students with low vision easily track numbers. Includes 10 charts (5 with highlighting and 5 without highlighting) and a large print guidebook.

5-82710-00 \$15.00

## Geometry Tactile Graphics Kit

Set of thermoformed raised-line drawings depicting geometry concepts, figures, and relationships. Graphics are larger and easier for students to measure than those in braille textbooks.

Recommended ages: 12 years and up.

1-08841-00 \$127.00

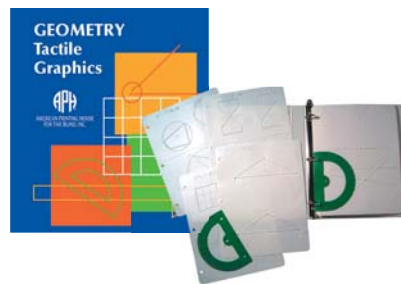

## Geometric Forms

Introduces students to the circle, square, and triangle. Includes 3 plane figures, 4 solid figures, and 1 white plastic sheet illustrating the shapes in black, raised lines.

Recommended ages: 5 years and up.

1-03410-00 \$52.00

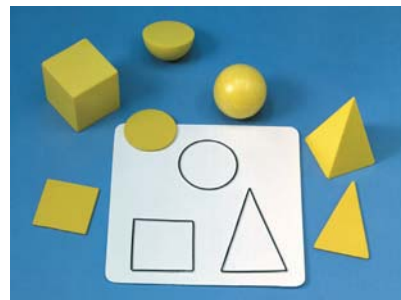

## Venn Diagram Template Kit

A Venn diagram or set diagram shows all possible logical relations between a finite collection of sets. Kit includes 15 sheets with two-circle diagrams and 15 sheets with three-circle diagrams, sized to allow for braille labeling in all sections and in the outer margins. The outlines of the circles are made in contrasting line styles so they are easily distinguishable, both visually and tactually. These heavy, consumable sheets may be tooled directly or used in a braillewriter. Includes a total of 30 sheets, measuring 11.5 x 11 inches.

1-04095-00 \$37.00

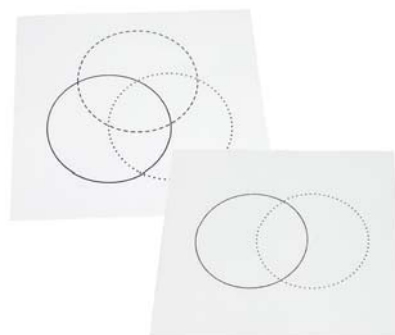



## Braille/Large Print Protractor

Bold large print numbers and raised dots mark the 180 degrees of this protractor, with markings every 5 degrees. The lines are bold and the type is 18 point. This protractor features a pivoting wand. When aligned with a certain degree measurement, the corresponding angle is created by the wand and the bottom edge of the protractor.

**1-04115-00** \$23.00

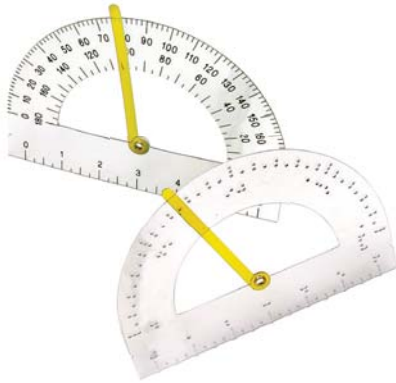

## Large Print and Tactile Protractors

Students can use the same convenient measuring tools in both classroom and assessment situations. Both protractors are made of lightweight, clear plastic and feature a moveable, transparent yellow wand. Notches on bottom left and right allow for pinning to a surface.

**Large Print Protractor (4-pk)**  
**1-04116-00** \$44.00

**Tactile Protractor (4-pk)**  
**1-04117-00** \$43.00



## Fractional Parts of Wholes Set

Tactile circles introduce the concepts of wholes, halves, thirds, and fourths. This set contains one work tray with three form boards and 3-inch diameter circles, one whole and the others cut into halves, thirds, and fourths.

Recommended ages: 5 years and up.

**1-03290-00** \$64.00

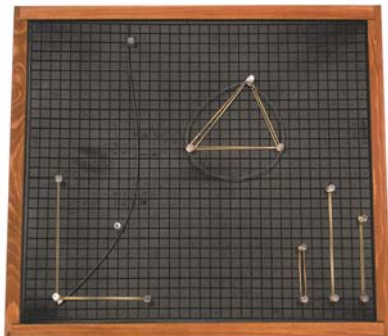

## Graphic Aid for Mathematics

Construct geometric and other figures and graphs related to arithmetic, algebra, geometry, trigonometry, and calculus. Consists of a cork board mounted with a rubber mat embossed with a 34 x 30 grid of 1/2 inch squares. Included are three flat spring wires, 14 push pins, and rubber bands.

Recommended ages: 8 years and up.

**1-00460-01** \$221.00

## Brannan Cubarithm Slate and Cubes

Young students may find it easier to use this device rather than a braille to align mathematical problems. A rubber frame with a 16 x 16 grid pattern of nests will hold small plastic cubes numbered 0 through 9 in braille (no print). Frame and cubes are sold separately.

Recommended ages: 6 years and up.



**Cubarithm Slate**  
1-00320-00 \$26.00

**Plastic Cubes Set of 100**  
1-00330-00 \$21.00

## Nemeth Code Reference Sheet for Basic Mathematics

Listing of common symbols from the Nemeth Braille Code for Mathematics.

**Print**  
7-87500-00 \$15.00

**Braille**  
5-87400-00 \$15.00



## Math Drill Cards in Braille and Large Print

These handy math skills reinforcing cards are sold in five separate sets. Number & Math Sign set have a math sign or number sign in braille and large print and braille on opposite sides. Has a math fact with the answer on opposite sides. Braille is Nemeth Braille Code for Mathematics.

Recommended ages: 5 to 10 years.

**Note:** Some assembly required. These cards can be used with APH's Card Chart Kit, 1-03550-00.

**Number & Math Signs**  
1-03551-00 \$17.00

**Multiplication**  
1-03554-00 \$15.00

**Addition**  
1-03552-00 \$15.00

**Division**  
1-03555-00 \$13.00

**Subtraction**  
1-03553-00 \$16.00





## Quick Pick Math

This math game consists of a plastic packet with 50 large print/braille cards. To play, the student inserts the included tool in one of four holes in the front of the plastic packet. If the answer is correct, the card will slide out. If the answer is incorrect, the card will not pull out. Transcribed in Nemeth Braille.

Recommended ages: 5 years and up.

### Addition

**1-03570-00** \$59.00

### Subtraction

**1-03571-00** \$60.00

### Multiplication

**1-03572-00** \$60.00

### Division

**1-03573-00** \$60.00



## Quick Pick Counting

A game designed to help young children learn to count to 12 with raised-line symbols and braille numbers.

Recommended ages: 4 years and up.

**1-03574-00** \$50.00

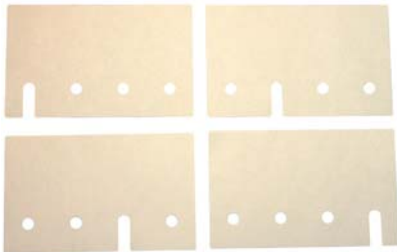

## Quick Pick Cards Set, Blank

Includes 50 blank game cards that can be used with the Quick Pick Game series.

**1-03577-00** \$7.00



## Large Print/Braille Toss-Away Ruler

This ruler, with markings in both large print and braille, is designed for the classroom or testing and assessment situations where an inexpensive measuring device is needed. 7-inch rulers marked with centimeters and inches are printed/embossed on assorted bright colors of heavy paper with high contrast numbers.

### Rulers (24-pk)

**1-03010-00** \$16.00



## Flexible Rulers (Braille/Large Print)

These flexible rulers allow tactual and visual measurement of flat or curved surfaces.

Recommended ages: 5 years and up.

**18-Inch (5-pk)**  
**1-03050-00 \$10.00**

**30-Centimeter (5-pk)**  
**1-03031-00 \$9.00**

## 1-Foot Braille Rulers

Plastic rulers taper on the edge. A metal caliper slide to aid in accuracy is included. Offered in Metric-English and English.

Recommended ages: 5 years and up.

**Metric-English  
 Measurement Ruler**  
**1-03100-00 \$12.00**

**English  
 Measurement Ruler**  
**1-03070-00 \$12.00**

## Meterstick (Braille)

Plastic, drilled for hanging, with raised lines every centimeter, and braille every other centimeter; thick raised lines for decimeters.

Recommended ages: 5 years and up.

**1-03000-00 \$25.00**

## Braille/Large Print Yardstick

Made of durable white plastic, drilled for hanging. Has raised-line markings along one edge in 1/4 inch increments, with braille marking every inch. Black large print markings are along the opposite edge in 1/4 inch increments.

**1-03002-00 \$27.00**

## Transparent CCTV Rulers

These flexible, see-through vinyl rulers make it easier to measure items magnified by a CCTV (closed-circuit television). Each includes a set of 6 rulers.

**Yellow**  
**1-03008-00 \$15.00**

**Clear**  
**1-03009-00 \$14.00**

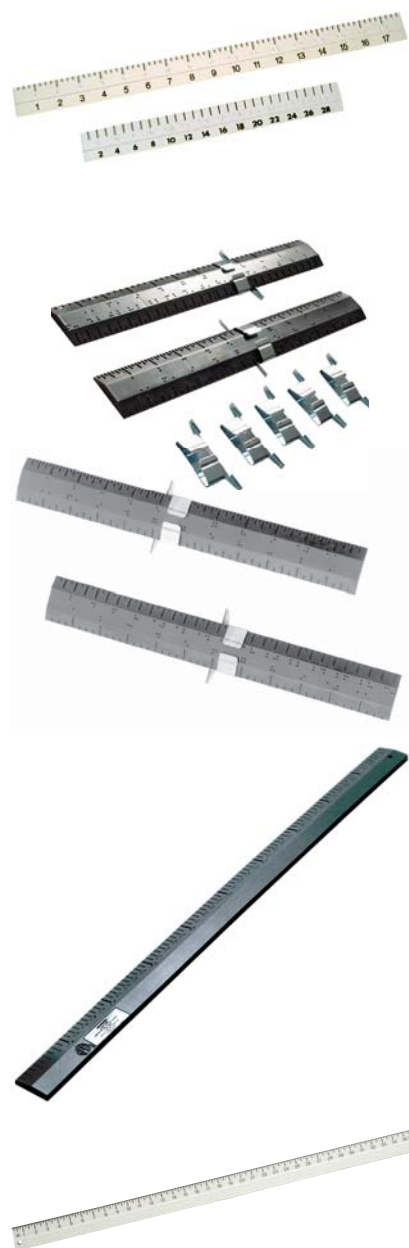

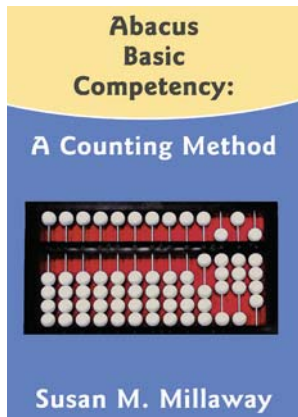

## Abacus Basic Competency: a Counting Method

Teaches abacus skills in the four basic math operations. This abacus instructional system uses the Counting Method instead of the traditional indirect method.

**Large Print**  
7-00219-00 \$17.50

**Braille**  
5-00219-00 \$36.00

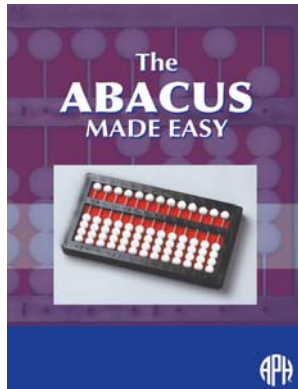

## The Abacus Made Easy

A simplified manual for teaching the Abacus.

**Note:** APH does not carry the braille edition of this manual in inventory for immediate delivery – when you order it, we will produce it for you as a special order; therefore, allow several weeks for delivery.

**Large Print**  
4-00100-00 \$51.00

**Braille**  
5-00220-00 \$79.00



## Using the Cranmer Abacus for the Blind

This manual instructs users who are blind or visually impaired in the use of the Cranmer Abacus. Gives instructions on how to add, subtract, multiply, divide, extract roots, compute decimals and fractions, and use the abacus as a calendar. Practice exercises are included.

**Note:** APH does not carry this publication in inventory for immediate delivery – when you order it, we will produce it for you as a special order; therefore, allow several weeks for delivery.

**Large Print**  
4-27110-00 \$81.00

**Braille**  
6-50100-00 \$45.00



## Hands-on Experience With the Cranmer Abacus

The concepts and skills covered in this DVD and accompanying booklet include how numbers are represented and how to perform the four basic math functions on the Cranmer Abacus.

1-30004-DVD \$25.00



## APH Offers Four Abacuses to Address a Variety of Needs

Each abacus consists of a black frame with white beads that slide against a red felt backing. The red felt background provides a good visual contrast and prevents beads from slipping.

### Beginner's Abacus

Reinforces beginning mathematical concepts, includes print guidebook. Braille guidebook available separately.

Recommended ages: 5 to 7 years.

1-03180-00 \$30.00

### Expanded Beginner's Abacus Kit

This abacus lends itself to preparing a young student for the Cranmer Abacus. The simple design allows for enhanced readability for "little fingers." Includes print guidebook. Measures 5.37 x 3.25 x 0.75 inches.

Recommended ages: 5 to 7 years.

1-03181-00 \$41.00

### Cranmer Abacus

A 13-rod abacus, beads have a 3/8 inch diameter. An optional metal coupler is available for linking two abacuses together.

Recommended ages: 5 years and up.

1-03150-00 \$36.00

### Large Abacus

Young students and those without fine motor skills can benefit from this large 13-rod abacus. Beads are 1/2 inch in diameter.

Recommended ages: 5 years and up.

1-03170-00 \$39.00

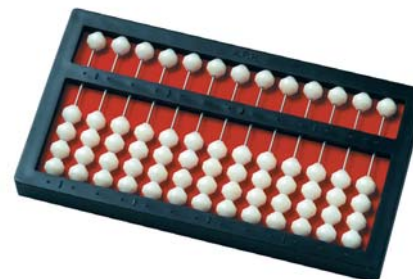



### Analog Clock Model

Helps teach time-telling concepts. Has braille and raised large print markings, and hands that are easily rotated. Model has no motor.

Recommended ages: 6 to 10 years.

1-03125-00 \$10.00

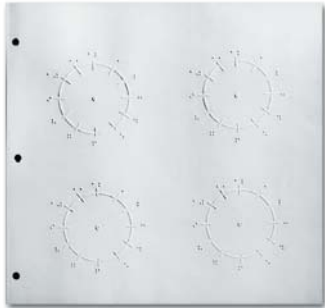

### Clock Face Sheets In Braille

Each sheet contains four embossed braille clock faces. Clock hands can be added to these blank clock faces. Embossed on 11 1/2 x 11 inch manila transcribing paper (25-pk), 3-hole punched.

Recommended ages: 6 to 10 years.

1-03111-00 \$16.00

## Important Icon Legend



### CVI Icon

Products with this icon may be appropriate for learners diagnosed with CVI. Comprehensive assessment should determine which products are best matched to your learner's needs.



### Safety Warnings Icon

Please note and follow the small parts choking hazard and other warnings indicated for certain APH products.



### UEB Icon

Products with this icon are transcribed in Unified English Braille (UEB).



### Replacement and Optional Parts Available Icon

Products with available replacement parts are marked with this icon. Refer to the Replacement Parts Catalog on our website.



### Downloadable Manuals

Most APH products have manuals available for immediate, free-of-charge downloading for printing or embossing as needed. Please visit [aph.org](http://aph.org) to download a manual.



### New Product



### Revised Product

# Science and Health Section Index



Adapting Science for Students w/VI .....	69	Tactile Punnett Squares.....	70
Adapted Science Materials Kit <b>N</b> .....	66	Touch, Label, & Learn Poster .....	70
Basic Science Tactile Graphics .....	69	<b>Science and Health Related Products</b>	
Basic Tactile Anatomy Atlas .....	69	Calendar Kits .....	99
DNA-RNA Kit .....	67	Card Chart Kit .....	99
DNA Twist .....	67	Nemeth Code for Mathematics and Science.....	168
Earth Science Tactile Graphics <b>N</b> .....	68	Nemeth Tutorial .....	51
Genetic Code Large Print Braille .....	70	Orion TI-84 Plus Talking Graphing Calculator.....	53
Life Science Tactile Graphics .....	69	Paint by Number Safari Series .....	76
Light In-Sight: Reflection & Refraction Kit .....	67	Portable Sound Source .....	81
Periodic Table of the Elements .....	70	Wooden Junior Constructo Set .....	164
Protein Synthesis Kit .....	66		
Sense of Science Series .....	71		
Tactile Demonstration Thermometer .....	67		



## Adapted Science Materials Kit **N**

Designed for K-12 students, this Kit includes many items originally devised by educators at the Lawrence Hall of Science in Berkeley, California, and enables students with visual impairments to participate in science lessons and experiments alongside their sighted peers. All items fit in the APH Innovations Tote Bag.

### Includes

- Waterproof Information Card
- Modified 1 L and 100-ml plastic beakers
- 100 ml and 50 ml plastic graduated cylinders with tactile braille scale floats
- 50 ml syringe with stop
- Balance with beam, base, and cups
- Mass set with 1-, 20-, 10-, and 5-g mass pieces
- Funnel stand
- Talking Celsius/Fahrenheit digital thermometer
- APH sorting trays
- Histogram board with stickers
- Large print braille meter tape with 0.5- and 1-cm gradations

**1-08997-00** \$259.00



## Protein Synthesis Kit **PARTS**

This Kit is an accessible, interactive model that expands on the molecular biology concepts introduced by the DNA-RNA Kit. The Protein Synthesis Kit includes jigsaw puzzle-like pieces representing transfer RNA nucleotides, Stop and Start subunits, all twenty amino acids, and the APH Genetic Code Large Print Braille.

**1-08975-00** \$289.00

## DNA Twist

Demonstrates an accessible structure of the DNA molecule. Shipped flat and easily twists to form the familiar double-helix configuration. The included stand holds the model in its twisted shape. A large print instruction booklet provides information about DNA and educational resources.

1-08978-00 \$57.00



## DNA-RNA Kit

This Kit provides students with a sturdy and dependable model, improving on other available molecular biology models.

1-08979-00 \$127.00



## Tactile Demonstration Thermometer

Allows students to independently read, set, and compare temperatures. Has a two-textured, two-colored adjustable “mercury column” with an easy-grip tactile indicator and comparable Fahrenheit and Celsius scales presented in both large print and braille.

Recommended ages: 6 years and up.

1-03020-00 \$121.00



## Light In-Sight: Reflection & Refraction Kit

This Kit enables science and physics students who are visually impaired to construct ray diagrams related to light reflection and refraction. Unlike other tactile graphics, which are often static, diagrams constructed using this product are malleable, making the teaching and learning process interactive and dynamic.

Recommended ages: 12 years and up.

1-08286-00 \$199.00

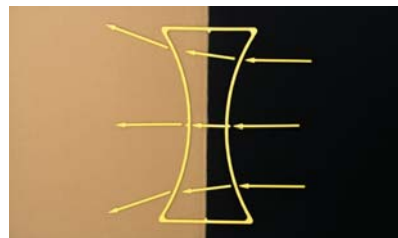

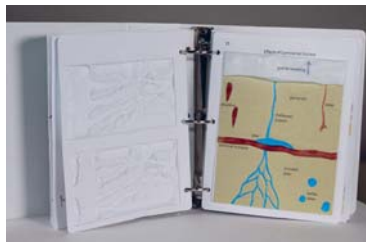
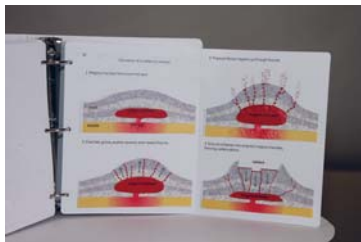
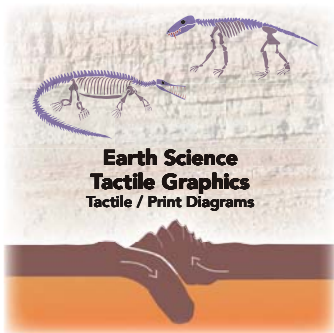

## Earth Science Tactile Graphics

This collection of vacuum-formed, full-color, raised-line tactile graphics related to Earth Science serves as a reference volume intended to supplement the graphics in a student's classroom textbook.

The graphics included in this kit are rendered in full color with several types of lines and textures, in addition to differing heights. Diagrams are labeled in print and braille, and teachers can add to, or change, the labels with self-adhesive braille label material. All tactile graphics are printed and vacuum-formed using sturdy, high-grade plastic, and are three-hole punched to place in a binder.

Instructional hints are provided for each tactile graphic in the Teacher's Guide, which is included in the binder. Teachers are encouraged to use the tactile images to augment lessons for students who are not using standard printed textbook diagrams. Effective use of the tactile images depends on a foundation of tactile reading skills, student's hands-on experiences, and verbal descriptions from the teacher. The large print Teacher's Guide is also available in accessible HTML and BRF formats on the APH Website with purchase of the product.

### Some topics covered by this set of tactile graphics are

- The Rock Cycle
- Earth's Internal Structure
- Convection Currents in Earth's Mantle
- Continental Drift
- Radioactive Decay
- Geologic Time Scale
- Glaciers
- Volcanoes
- Fault Types
- Isotherms
- Tectonic Plate Boundaries
- Water Cycle
- Carbon Cycle
- Groundwater Features
- Weather Fronts
- The Greenhouse Effect
- Internal Structure of Terrestrial Planet
- Composition of Gas Giants
- Hertzsprung-Russell Diagram
- Structure of a Comet

**1-03131-00 \$449.00**

## Basic Science Tactile Graphics

Basic Science Tactile Graphics are vacuum-formed, raised-line drawings depicting objects, concepts, and relationships that are covered in nearly all elementary science textbooks.

They are intended to supplement, not replace, the graphics in a student's adapted textbook. Instructional hints and suggestions are given for each tactile drawing. Includes 52 graphics.

1-08850-00 \$135.00

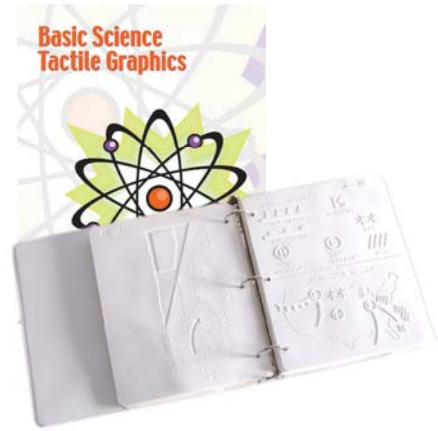

## Life Science Tactile Graphics

Vacuum-formed, full-color, raised-line tactile graphics intended to supplement the figures and diagrams in life science textbooks. Life Science Tactile Graphics depict organisms, processes, concepts, and patterns which are typically covered in middle and high school life science courses. Includes 56 graphics. Braille Teacher's Guide available as a free download.

1-08840-00 \$409.00

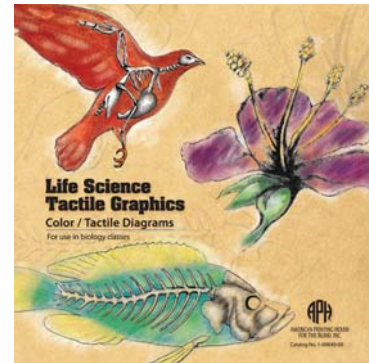

## Adapting Science for Students With Visual Impairments: A Handbook for the Classroom Teacher and Teacher of the Visually Impaired

Designed to assist teachers, particularly those with minimal science background and/or Vi experience, in making operational science activities accessible to students who are visually impaired and blind. The handbook is sold with 5 each of the Advanced Preparation and Skills Checklists, which are also available separately.

7-00000-00 \$98.00

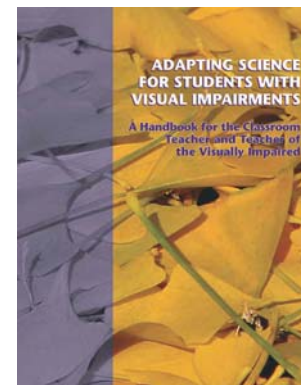

## Basic Tactile Anatomy Atlas

This two-volume set of thermoformed tactile graphics gives a comprehensive overview of the human body. Each tactual diagram has braille and print labels with a brief braille description. A print version of each brailled text is included.

Recommended ages: 12 years and up.

1-08845-00 \$318.00





## Touch, Label, and Learn Poster: Human Skeleton (Anterior View)

This kit provides an interactive presentation for reviewing the names, locations, and relationships of human skeletal bones. Poster has a dual tactile/color design.

Recommended ages: 8 years and up.

1-08976-00 \$179.00

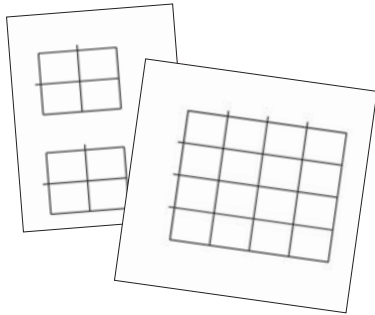

## Tactile Punnett Squares

A Punnett Square is a diagram that is used by biologists to determine the probability of offspring genotypes. The Punnett Square is a visual representation of Mendelian inheritance. Printed and embossed on 90 lb. 8 1/2 x 11 inch paper; 25 sheets per resealable envelope.

Recommended grades: Middle through high school.

**4-Box Punnett Squares**

1-08890-00 \$27.00

**16-Box Punnett Squares**

1-08891-00 \$27.00

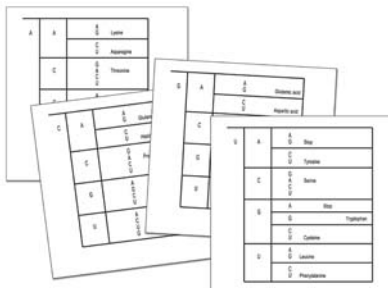

## Genetic Code, Large Print-Braille

The genetic code is the set of rules by which information encoded within genetic material (DNA or mRNA sequences) is translated into proteins (amino acid sequences) by living cells.

Recommended grade: High school.

1-08977-00 \$42.00

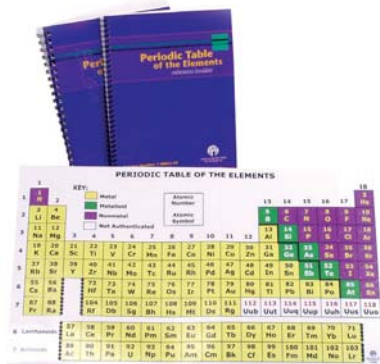

## Periodic Table of the Elements Reference Chart and Booklet

This reference table is a durable and colorful print/braille chart. It comes with a reference booklet in print or in braille (you choose the format) that contains additional tables listing the elements. Measures 22 1/2 x 13 inches.

**Reference Chart w/Booklet in Print**  
7-08855-00 \$44.00

**Reference Chart w/Booklet in Braille**  
5-08855-00 \$53.00



## Sense of Science Series

Sense of Science is a hands-on, multi-sensory series designed to make the world of science accessible, understandable, and enjoyable.

The main component in each Sense of Science kit is a set of colorful, raised-line overlays designed to be used with a light box, or as stand-alone items. An accompanying large print guidebook (braille edition available separately) suggests activities using the overlays and supplemental teacher-provided materials to enhance and extend the learning experience. Each kit comes with two work trays and a variety of visual tactile overlays.



### Sense of Science: Plants

A unique science series for students with visual impairments and other students who may benefit from a multi-sensory approach to learning.

Recommended ages: 5 to 10 years.

1-08980-00 \$363.00

### Sense of Science: Animals

Activities incorporate a step-by-step procedure, an extended activity, a visual adaptation, math and language connections, and a “science tidbit.”

Recommended ages: 5 to 10 years.

1-08990-00 \$562.00

### Sense of Science: Astronomy

This set of materials is appropriate for a broader range of ages and grade levels of students with visual impairments and blindness. Activities are complemented by the included visual/tactile overlays and fold-out 2-D displays.

Recommended ages: 8 years and up.

1-08991-00 \$379.00

# Social Studies: History, Geography, and Economics Section Index



Interactive U.S. Map with Talking Tactile Pen .....	74
National Geographic Picture Atlas .....	73
State Maps Collection .....	74
Tactile World Globe .....	73
U.S. Puzzle Map .....	74
U.S. & Canada Tactile/Print Atlas .....	74

World at Your Fingers .....	73
World Maps .....	73

## **Social Studies Related Products**

Braille Transcribers Kits .....	112
Calendar Kits .....	99
Nearby Explorer .....	137–138

## Tactile World Globe

Offers more tactile and braille information than provided by previous APH tactile globes. A clear plastic overlay covers a standard 12-inch political globe with a non-skid wood base.

### Includes

- Raised topographical and area, with all continents labeled in braille
- Major oceans labeled in braille
- Raised latitude and longitude lines labeled in braille (as space accommodates)
- Discernible, contrasting raised lines for the Equator, International Date Line, Prime Meridian, Tropic of Cancer, and Tropic of Capricorn

Recommended ages: 10 years and up.

1-01551-01 \$139.00



## World Maps

Thermoformed on durable 11.5 x 11 inch vinyl, these tactile maps are a comprehensive aid to geographic instruction and orientation. With tactile maps of all the continents, regions, and countries of the world, these maps use clear variations in height and texture. Labeled in braille, the facing pages have key information in braille and large print.

5-06001-00 \$165.00

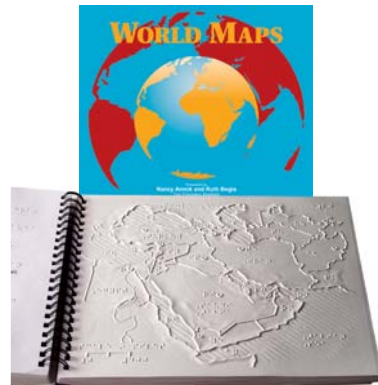

## National Geographic Picture Atlas of our Fifty States, Braille Edition

Comprehensive braille/tactile atlas has detailed maps and information for each state. Three maps of each state.

Recommended ages: 6 years and up.

5-87431-00 \$519.00



## World at Your Fingers

This large tactile reference map shows the major oceans and land masses using high-contrast raised surfaces, braille and print labels, and textured lines and areas. It also shows major mountain ranges, rivers, and lines of longitude and latitude.

1-01190-00 \$132.00



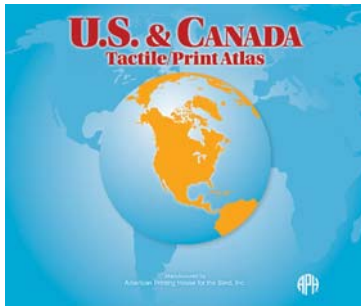

## U.S. & Canada Tactile/Print Atlas

The U.S. & Canada Tactile/Print Atlas is a reference volume of thematic maps for use in geography, history, or social studies classes, or for general informational use outside the classroom.

Recommended ages: 11 years and up.

1-01920-00 \$161.00



## U.S. Puzzle Map

This take-apart topographical map of the United States measures 32 1/2 x 18 inches and has many features to help make learning fun for all students.

Recommended ages: 7 years and up.

7-01140-00 \$446.00



## State Maps Collection

Each State Maps Collection is a set of embossed and printed outline maps for a region of the United States. Add to the images with tracing wheel lines, craft ink, glued-on textures, etc. Add braille labels as needed.

### Northeast Region

1-04110-00 \$45.00

### Central Region

1-04112-00 \$45.00

### Southeast Region

1-04111-00 \$45.00

### Western Region

1-04113-00 \$44.00



## Interactive U.S. Map With Talking Tactile Pen

This map's combination of tactile, visual, and audio feedback allows for independent, self-guided study by students and adults with visual impairments, as well as by sighted peers. The Talking Tactile Pen is a non-writing stylus.

Recommended ages: 8 years and up.

1-01150-00 \$276.00

# Fine Arts Section Index



Braille Beads: APH Starter Kit .....	77
Color-by-Texture Circus Coloring Pages .....	77
Color-by-Texture Marking Mats .....	77
Paint by Number Safari	
Tropical Rainforest .....	76
Under the Sea <b>N</b> .....	76
Paint Pot Palette .....	77
Time for Art .....	76

## Fine Arts Related Products

APH InSights Art Calendar .....	171
DRAFTSMAN Tactile Drawing Board .....	97
Feel 'n Peel Sheets: Carousel of Textures ...	95
Picture Maker .....	141
Quick-Draw Paper .....	98
Sticky Dots Adhesive .....	41
Tactile Compass for Math and Art .....	55
Tactile Graphic Line Slate .....	93

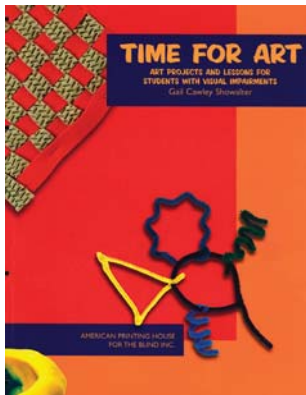
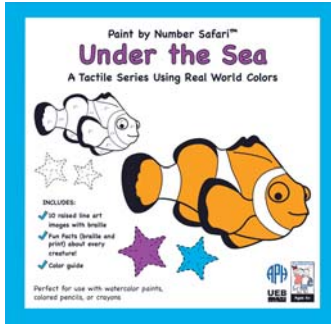
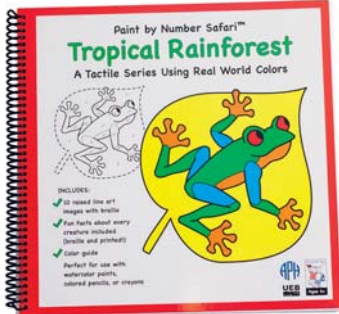

## Paint by Number Safari™

Learn about art, nature, and colors with the Paint by Number coloring series! Each Paint by Number set includes 10 raised-line drawings of real-world subjects that are printed and embossed on heavy paper, with fun facts in both print and braille, and a color guide.

Recommended ages: 6 years and up.

## Tropical Rainforest **UEB**

Wide, solid, embossed lines identify the animal, and thin embossed lines depict color separation on the animal's body. The dashed lines identify background images such as leaves, branches, and flowers. Solid raised areas identify parts of the images that are too small to fill with color, such as small bugs and small body parts.

1-03934-00 \$39.00

## Under the Sea **N UEB**

Students will enjoy perfecting their art skills as they learn about the colors and creatures found under the sea. Wide, solid, embossed lines identify the sea creature, while thin embossed lines denote color separation on the creatures' body. Dashed lines identify background images, and solid, raised areas identify parts of the images that are too small to fill with color.

1-03936-00 \$39.00

## Time For Art: Projects and Lessons for Students With Visual Impairments

A handbook for teachers and parents that explains how to instruct students with visual impairments in art, how to handle the media being explored, and points to consider in art program planning.

Companion lessons are offered for each project and often explore other areas such as science, history, or mathematics.

8-03800-00 \$26.00

## Color-by-Texture Circus Coloring Pages

These theme-based coloring pages complement APH's Color-by-Texture Marking Mats. These raised-line coloring pages facilitate a variety of art activities for young children and students who are visually impaired and blind.

Recommended ages: 6 years and up.

1-03333-00 \$27.00



## Color-by-Texture Marking Mats

The primary goal of this product is to invite tactile learners to be active participants in art activities by making their own choices based on color and texture preferences.

The textured mats and related items can also be used by adults for more sophisticated art creations. The kit is ideal for promoting shared art experiences within a variety of instructional settings with sighted peers.

1-03332-00 \$144.00



## Paint Pot Palette: Creating Art Through Touch

Includes a set of custom-made, whimsical drawings by San Francisco artist Debi Harrison titled Color SENSEation. The pictures are printed and embossed on heavy paper; each picture is titled in print and braille. The embossed lines make it easy to trace the subjects with the fingers and then follow with a crayon or paint brush. Paint Pot Palette is a collaboration between PlayAbility Toys and APH. Replacement parts are available from PlayAbility Toys, [www.PlayAbilityToys.com](http://www.PlayAbilityToys.com)

1-03933-00 \$53.00



## Braille Beads: APH Starter Kit

These small, plastic rectangular beads have braille on one side and incised print letters on the other. Kit also includes fun image beads. Braille Beads measure 10mm tall x 8mm wide x 5mm deep (braille height is 0.52mm)

Recommended ages: 5 years and up.

1-08879-00 \$229.00



# Business and Vocational Education Section Index

FoldRite Letter Folding Tool..... 78  
 Prevocational Skills Development Materials... 78

## Business and Vocational Education Related Products

Analog Clock Model..... 64  
 Braille  
     DateBook ..... 155  
     Pocket Folders ..... 120  
 EZ Track Products..... 158

JAWS and ZoomText..... 145  
 Keitzer Check Writing Guide ..... 154  
 Learn Keys: Verbal Keyboard Feedback..... 101  
 MiniBook Braille Quick-Note Products..... 155  
 Money Handling and Budgeting ..... 157  
 Super-Sized Folders ..... 120  
 Transition Tote System ..... 149  
 MATT Connect..... 143  
 Wooden Junior Constructo Set ..... 164



## FoldRite: Letter Folding Tool

Made of durable plastic, designed to make folding 8 1/2 x 11 inch paper a snap. Consists of two plastic, hinged plates. Letters can be tri-folded by placing the paper between the plates and folding the FoldRite over twice. Can also be used to create strips of blank braille paper that fit into a business envelope.

**1-08009-00** \$5.00

## Prevocational Skills Development Materials **PARTS**

Designed for multi-handicapped students, this kit and other materials suggested in the guidebook helps develop manipulative skills, such as matching, sorting, counting, assembling, and packaging.

Recommended ages: 10 years and up.

**1-08000-00** \$473.00



# Physical Education Section Index



APH Sound Balls .....	80
Everybody Plays! .....	80
Games for People with Sensory Impairments .....	80
Going Places .....	81
Gross Motor Development Curriculum .....	81
Jump Rope to Fitness Kit .....	82

Portable Sound Source .....	81
Rib-It-Balls .....	80
30-Love Tennis Kit .....	82
Walk/Run for Fitness Kit .....	82

## Physical Education Related Products

Push Button Padlock .....	159
---------------------------	-----



## APH Sound Balls

Features dual speakers and volume; two colors/two distinct sounds; two-tone sound, non-toxic/latex-free materials; durable; 7 1/2 inches in diameter.

**Boing Boing (Yellow)**  
1-07510-00 \$122.00

**Techno Beat (Red)**  
1-07516-00 \$122.00



## Rib-It-Balls

These fun balls are easy to grab and have high contrast ribbing. “Crinkly” fabric in the ribs adds an auditory component. These inflatable, latex-free multicolored balls have been designed in two-color combinations, making them easier for visual orientation, and are available in three sizes.

**14-Inch**  
1-07513-00 \$27.00

**18-Inch**  
1-07514-00 \$43.00

**30-Inch w/Pump**  
1-07515-00 \$75.00

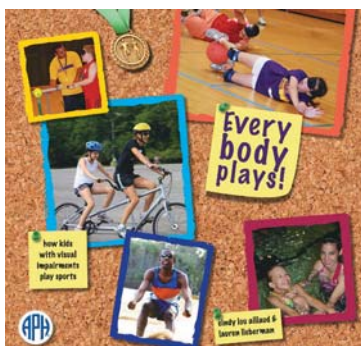

## Everybody Plays! How Kids With Visual Impairments Play Sports

A fun storybook that follows an elementary school-age child to a sports camp for children who have visual impairments, blindness, or deafblindness. Readers learn about sports and recreational physical activities that are enjoyed universally.

**Large Print/CD**  
7-13095-00 \$74.00

**Braille/CD**  
5-13095-00 \$38.00

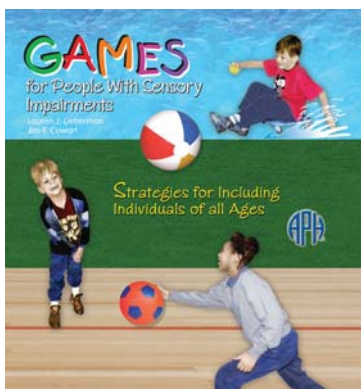

## Games for People With Sensory Impairments

A valuable book that initiates exploration and stimulates the reader’s creativity and resourcefulness!

Includes strategies for including individuals of all ages in physical activity. The authors draw on their extensive experience in teaching students of all ages who have visual impairments, blindness, deafblindness, and multiple disabilities.

Large Print with CD-ROM that contains an .html file. Braille version available as a free download.

7-08609-00 \$66.00

## Gross Motor Development Curriculum For Children With Visual Impairment

This three-part book, by authors Pamela Haibach, PhD, and Lauren Lieberman, PhD, addresses the specific skills of children with visual impairments based upon research findings on fundamental motor skills. The curriculum provides teachers and parents with a detailed breakdown of each locomotor skill and object control skill.

7-08400-00 \$36.00



## Portable Sound Source, Sport Edition

This lightweight sound source comes with a remote control and carrying strap. Create audio tones that provide directional cues for O&M, sound localization training, or playground games and sports. Braille Guidebook sold separately.

Recommended ages: 6 years and up.

1-03045-00 \$246.00



## Going Places: Transition Guidelines for Community-Based Physical Activities for Students who Have Visual Impairments, Blindness, or Deafblindness

This is a resource guide for teens and young adults that promotes independent physical activity.

It outlines a step-by-step process for choosing and participating in sports and other physical activities outside of the school arena. Includes a large print guide and CD.

7-13090-01 \$108.00

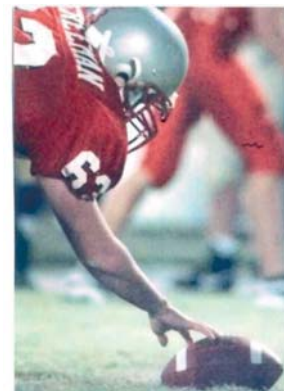



### 30-Love Tennis Kit

Whether practicing against a wall, playing singles against an opponent, or participating in a round of doubles, tennis is a great sport for practicing sound localization skills and socialization. Includes: 2 blindfolds and 2 rackets; set of 6 sound-adapted tennis balls; and 30-Love: Tennis Guidelines, large print and braille editions.

**1-08110-00** \$145.00



### Jump Rope to Fitness Kit

Did you know that 10 minutes of jumping rope can be as effective as 30 minutes of jogging? The APH Jump Rope to Fitness Kit provides individuals who are blind or visually impaired, the tools to jump rope independently, learn specific skills, and set goals.

Recommended ages: 9 years and up.

**1-07521-00** \$161.00



### Walk/Run for Fitness Kit

This Kit includes a personal guidewire system that can be set up in your backyard, a school, or a park. Includes two talking pedometers. If running or walking with a human guide, you can use the kit's adjustable tether, which is long enough to accommodate wheelchair users. Includes a shoulder sling pack for storage and travel. Guidewire measures 20 meters (21.9 yards).

**1-07520-00** \$181.00



# Communication Modes and Literacy Education Section Index



All-In-One Boards .....	91	Braille Alphabet and Numbers Card .....	101
Aluminum Diagramming Foil .....	97	BrailleBuzz <b>N</b> .....	85
APH Alphabet Card Folder .....	101	Braille Alphabet and Numbers Card .....	101
Antique Ivory Opaque Paper .....	118	Braille Paper .....	115–116
Beginner’s Writing Paper .....	113	Braille Slates, Styluses, and Erasers .....	91–93
Big Cell .....	103	Braille Transcriber’s Kits (BTK) .....	112
Bold-Line Tactile Graph Sheets .....	119	Brailers (Braillewriters) .....	113
Bold Print Paper and Notebooks .....	116–117	Braillewriting Dot by Dot .....	93
Braille Binders, Folders, Notebooks .....	114, 119–120	Building on Patterns Series (BOP):	
Brailleable Labels and Sheets <b>R</b> .....	87	Prekindergarten <b>N</b> .....	106–107
		Kindergarten–2nd Grade .....	108–111

# Communication Modes and Literacy Education Section Index

Calendar Box Stabilizer	96	Student Starter Pack	93
Calendar Kits	99	Super-Sized Folders	120
Card Chart Kit	99	Swail Dot Inverter	98
Covers for Braille Documents	114	Swing Cell Compact	103
Desktop Reading Stand	102	Tactile Book Builder Kit <b>N</b>	86–87
Dividers for Braille Notebooks	114	Tactile Connections	95
DRAFTSMAN Tactile Drawing Board	97	Tactile Graphics Kit	97
Early Braille Tradebooks (EBT): Rigby		Tactile Graphic Line Slate	93
Nonfiction Kits <b>R</b>	88–89	Tactile Marking Mat	111
PM Platinum Kits	88, 90	Talking Typewriter	100
Embossed Pencil Writing Paper	112	Teaching Touch	104
Expandable Calendar Boxes	96	Textured Paper Collection	97
Feel 'n Peel Series	94–95	Touch and Tell	104
Flip-Over Concept Books	105	Weekly Reader: Special Print/Braille	104
Four Line 8-dot Slate <b>N</b>	92	White Braille Paper <b>R</b>	115
GrandStand: Portable Reading Ease	102	Word Associations Print/Braille Labels	99
Graph Sheets	118–119		
Graphic Art Tape	96	<b>Communication Modes and Literacy Related Products</b>	
IntelliTactiles Pre-Braille Concepts	98	APH Signature Guide	159
Large Magnetic Dry Erase Board	85	Braille Beads	77
Learn Keys: Verbal Keyboard Feedback	101	Braille Contraction Cards	44
Mailing Envelopes for Braille	114	Braille DateBook	155
Match-It-Up Frames	85	Clock Face Sheets in Braille	64
Patterns Pre-Braille Program	106	Deafblind Pocket Communicator	154
Peg Slate	93	Expanded Dolch Word Cards, UEB	44
PermaBraille <b>R</b>	116	EZ Track Products	158
Plastic Binder Envelopes for Braille	120	Lots of Dots Series	42
Pop-A-Cell	103	MiniBook Braille Quick-Note Products	155
Quick Check	101	Moving Ahead Series	32
Quick-Draw Paper	98	Nemeth Tutorial	51
ReadWrite Stands	102	On the Way to Literacy Series	26–30
SAM: Symbols and Meaning	95	Reach & Match	21
Setting the Stage	104	SQUID Tactile Activities Magazines	164
Shafer Reading Stand	103	Tactile Editing Marks Kit	46
SlateHolder	92	Visual Brailier	146
STACS Kit	96		

## BrailleBuzz

BrailleBuzz™ is an instructional toy for young braille learners ages two to five. It encourages practice with braille characters and phonics, similar to a variety of audio-based toys that teach print writing.

BrailleBuzz resembles a cartoon bumblebee, encouraging little ones with audio feedback. A friendly recorded human voice and fun sounds are paired with a Perkins-style braille keyboard, designed with little hands in mind.

### Three Modes of Play

- Phonics Mode: fun sound and letter associations are made.
- Keyboard Mode: all key combinations are announced with dot numbers.
- Letters Mode: dot number announcement reinforces the relationship between reading letters and writing on the keyboard.

Requires 2 AA batteries (not included).

1-03935-00 \$99.00



## Large Magnetic Dry Erase Board

The Large Magnetic Dry Erase Board can be used as a standalone product to accommodate activities involving magnetic-backed pieces or activities requiring dry-erase markers. The working surface of the board measures 21 3/8 x 13 1/2 inches and is affixed to a blue, rigid vinyl that provides a visual border.

Recommended ages: All.

1-03557-00 \$41.00



## Match-It-Up Frames

Use these frames in a variety of ways to facilitate learning tasks related to matching, sequencing, patterning, counting, and much more! Large Set and Small Set activities can be custom-designed by teachers and parents to address specific learning needs of students who are blind and visually impaired, as well as those with multiple disabilities.

Recommended ages: 3 years and up.

### Small Set

1-08828-00 \$141.00

### Large Set

1-08827-00 \$219.00

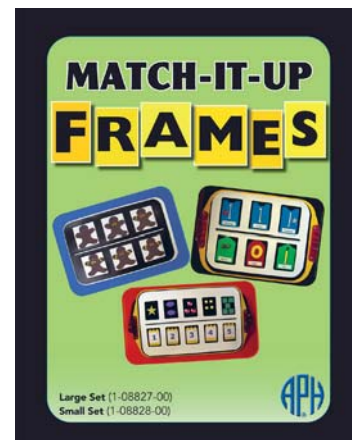

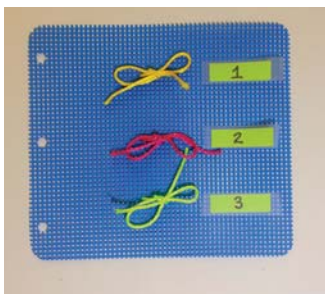
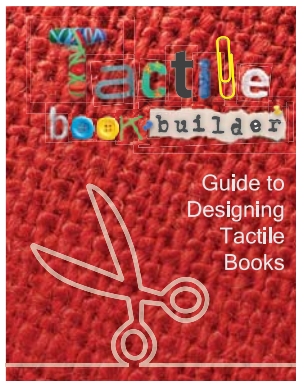

## Tactile Book Builder Kit **N**

“Build” a book and create a child’s connection to literacy!

The Tactile Book Builder Kit contains a wide selection of materials enabling users to quickly custom-make books of many kinds—firsthand experience storybooks, concept books, simple texture books, informational books, alphabet books, adaptations of print books, and more!

A large, varied assortment of pre-cut pages permits easy attachment of objects and presentation of collaged textures, shapes, raised line drawings, and multisensory elements as illustration. Braille paper, braille label material, and clear page protectors offer multiple ways to add braille and print text. All pages fit into sturdy plastic binders with recloseable safety loops. Binders feature an open-view front to allow users to create and insert their own tactile cover art.

### Includes

- 4 large binders
- 3 small binders
- 16 board stock pages, various colors
- 20 sheets braille paper, folded pages
- 16 card stock pages
- 4 fabric pages for hook and loop attachments
- 4 magnetic pages
- 10 needlepoint canvas pages, various colors
- 20 page protectors
- 24 polyblend pages, various colors
- 6 pocket pages
- SoundPage for binders, 3 recording devices
- 5 Ziploc® pages
- Brailleable clear plastic label material 40 large, 100 small
- Braille templates, pack of 3 sizes
- Assorted attachments—hook and loop adhesive-backed strips and coin sets, magnetic attachments, and zip ties
- Guide to Designing Tactile Books, print (a 120-page illustrated handbook assisting teachers and caregivers in creating books and tactile illustrations matched to the skills of a particular child).



**Among the topics addressed include**

- Learning through touch
- Designing tactile, multisensory, interactive illustrations to represent features tactual learners find significant
- Principles of good tactile design
- Specific design guidelines for various types of tactile illustrations and suggested sequence of difficulty
- Fine motor, exploratory, and cognitive skills needed to examine and interpret tactile illustrations
- Photos and descriptions of exemplary tactile books
- Lists of craft items and materials for use in tactile books
- Numerous “story-starter” ideas for books across a range of ages and abilities



APH products to use with Tactile Book Builder: Picture Maker Textured Shapes (61-151-168), Picture Maker Geometric Textured Shapes (1-08838-01), and Classroom Calendar Kit Day Numbers (61-410-004).

**1-08826-00 \$519.00**

**Brailleable Labels and Sheets R**

These clear, blank, self-adhesive labels can be brailled and used on items around home, school, and office.

The pre-cut, peel-off Large and Small labels accommodate braille lines up to 15 cells wide, with four lines on the large and two on the small labels. Full-Size and Pin-Fed Sheets offer more room for brailing and can be cut to size. A printed SimBraille® sheet is included to assist in determining size and placement.

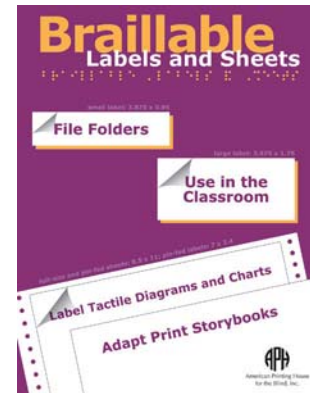

**Assorted Pack**  
**(5 small, 5 large,**  
**10 full-size, and**  
**30 pin-fed sheets)**  
**1-08871-00 \$50.00**

**Small Label Pack**  
**(3.87 x 0.95) 10 sheets,**  
**18 labels per sheet**  
**1-08872-00 \$13.00**

**Large Label Pack**  
**(3.87 x 1.75) 10 sheets,**  
**10 labels per sheet**  
**1-08873-00 \$13.00**

**Full-Size Labels**  
**(8.5 x 11) 15 sheets**  
**1-08874-00 \$18.00**

**Pin-Fed Labels**  
**(8.5 x 11)**  
**30 continuous sheets**  
**1-08875-00 \$38.00**

**Pin-Fed Labels**  
**(7 x 2.4) 102 labels on a**  
**continuous sheet**  
 Not included in Assorted  
 Label Package.  
**1-08895-00 \$23.00**

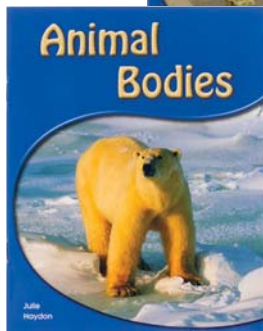
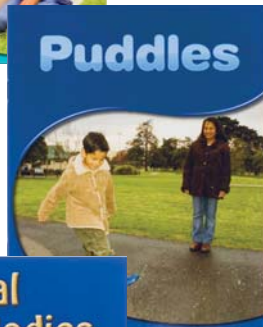
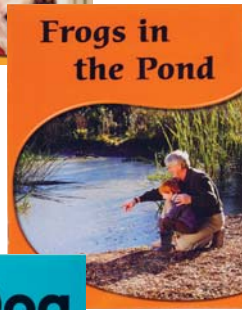
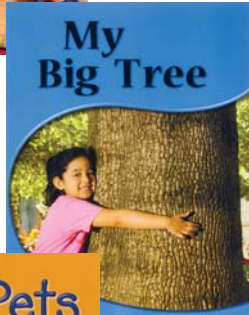
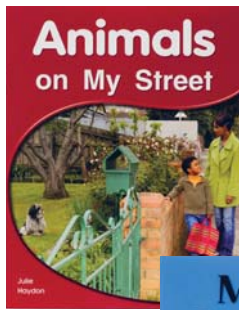

## Early Braille Trade Books

APH's Early Braille Trade Books combine commercially available books with braille labels for beginning readers. These kits include books, braille labels, and access to an interactive website: <https://ebt.aph.tech.org/>.

Rigby Literacy has consistently been recognized for quality and research-based reading materials. The Rigby series provides nonfiction books that are aligned with national standards and provide motivating texts that systematically build high-frequency words and reading skills.

These books are known for their meaningful stories that present a clear climax and resolution. Titles hook children with clear story lines, and the steady growth of sentence structure scaffolds text complexity for incremental reading success.

Each kit includes a Quick Start Guide, braille label packs, and storybooks.

### Features & Benefits

- Includes contracted or uncontracted braille labels.
- Packaged by Developmental Reading Assessment (DRA) and Fountas and Pinnell Reading Levels.
- Match books to each student based on his or her braille knowledge.
- Search for books by genre, core curriculum, and/or expanded core curriculum.
- Included interactive website allows you to:
  - access a book summary and activities designed for braille readers.
  - share or transfer student records to other teachers.
  - maintain a listing and percentage of contractions learned by each student – great for documentation at IEP meetings.
  - find books to use in conjunction with APH's Building on Patterns (BOP) series.

# Rigby Nonfiction Kits

## Kit 1

Braille, Nonfiction, Level 4-D

### Six books

- Animals on My Street
- Frogs in the Pond
- My Big Tree
- Our Dog
- Our Pets
- Puddles

## Kit 2

Braille, Nonfiction, Level 6-8-E

### Four books

- Animal Bodies
- Animals on Our Farm
- Mothers and Babies
- Our Fish

## Kit 3

Braille, Nonfiction, Level 10-F

### Four books

- Hot sunny days
- Rain is water
- The sun, the wind, and the rain
- Where did all the water go?

Recommended grades: 1 and up.

## Kit 1

**Contracted**  
3-00401-00 \$131.00

**Uncontracted**  
3-00402-00 \$131.00

## Kit 2

**Contracted**  
3-00403-00 \$92.00

**Uncontracted**  
3-00404-00 \$92.00

## Kit 3

**Contracted**  
3-00405-00 \$99.00

**Uncontracted**  
3-00406-00 \$99.00

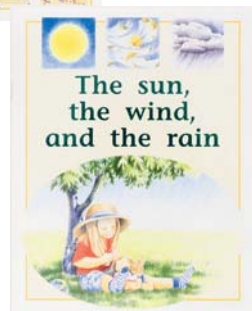
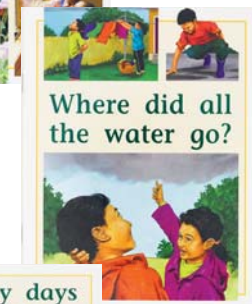
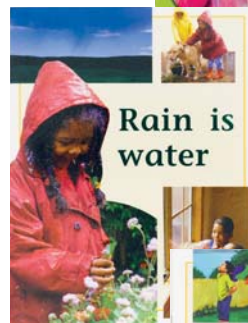
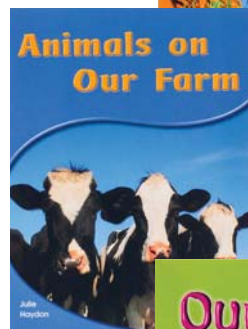
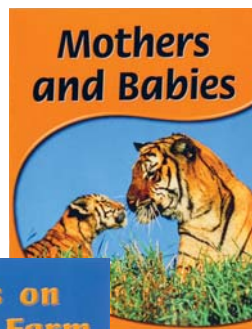



## Rigby PM Platinum Kits **UEB**

Recommended grades: Kindergarten and up.

### Kit 1

- Baby Lamb's First Drink
- The Baby Owls
- Hedgehog is Hungry
- The Lazy Pig
- Tiger, Tiger

### Kit 2

- The Big Kick
- The Bumper Cars
- The Little Snowman
- The Merry-go-round
- Wake up, Dad

### Kit 3

- Ben's Teddy Bear
- Ben's Treasure Hunt
- Father Bear Goes Fishing
- Hide and Seek
- Tom is Brave
- Where is Hannah?

Recommended grades: Kindergarten and up.

### Kit 1

Braille, Fiction, Level 3-C

<b>Contracted</b>	<b>Uncontracted</b>
<b>3-00301-00</b> \$109.00	<b>3-00302-00</b> \$109.00

### Kit 2

Braille, Fiction, Level 3-C

<b>Contracted</b>	<b>Uncontracted</b>
<b>3-00303-00</b> \$109.00	<b>3-00304-00</b> \$109.00

### Kit 3

Braille, Fiction, Level 4-D

<b>Contracted</b>	<b>Uncontracted</b>
<b>3-00305-00</b> \$129.00	<b>3-00306-00</b> \$129.00



## All-In-One Board

This multi-platform, easily-adjustable board from APH can be used in combination with either hook-and-loop accessories or magnetic pieces, as well as with dry-erase markers. Board can be positioned at a variety of angles. For classroom use with students of all ages.

Surface of board is 23 9/16 x 14 inches.

**1-08836-00** \$158.00



## All-In-One Board: Student Model

Sometimes called the smAll-In-One Board, this handy, smaller multi-platform, adjustable board can be used in the same way as the All-in-One Board. The smaller size accommodates portability and desktop use by an individual student with visual impairment and blindness. Surface of board measures 13 1/2 x 10 3/4 inches.

**1-08833-00** \$137.00



## Braille Slates, Styluses, and Erasers

All slates include a stylus. Stylus Key: L = Large Handle, S = Saddle, F = Flat

Recommended ages: 6 years and up.



### Braille Slates

#### Janus Interline

9 Cell, 11 Lines,  
Plastic (S),  
5 1/2 x 3 1/2 inches  
**1-00050-00** \$5.00

#### Interpoint Pins Up

28 Cell, Lightweight  
Metal (L), Slotted for  
Labeling Tape,  
8 1/4 x 1 3/4 inches  
**1-00081-01** \$74.00

#### Pocket Slate Pins Up

28 Cell, 4 Lines,  
Clear Plastic (L),  
8 1/4 x 1 3/4 inches  
**1-00078-00** \$11.00

28 Cell, Heavyweight  
Metal (L), Slotted for  
Labeling Tape,  
8 1/4 x 1 3/4 inches  
**1-00160-00** \$80.00

28 Cell, Black Plastic (L),  
8 1/4 x 1 3/4 inches  
**1-00080-00** \$11.00





## Braille Styluses

(all have a metal point, F = Flat)

**Large Yellow (F),**  
Fits in notebook or binder  
**1-00121-00 \$2.50**

**Small Green (F),**  
Fits in notebook or binder  
**1-00122-00 \$2.50**

**Saddle-Shaped**  
Plastic concave dip  
in handle  
2 5/8 x 1 1/4 inches  
**1-00120-00 \$2.50**

### Wood Handle

**Large**  
Side of Handle (F),  
2 3/8 x 7/8 inches  
**1-00200-00 \$2.50**

**Small**  
1 7/8 x 3/4 inches  
**1-00220-00 \$2.50**



## Braille Erasers

**Wooden**  
2 1/2 inches long  
**1-00270-00 \$3.00**

**Plastic**  
One Broad, One Narrow End,  
5 inches long  
**1-00280-00 \$3.00**

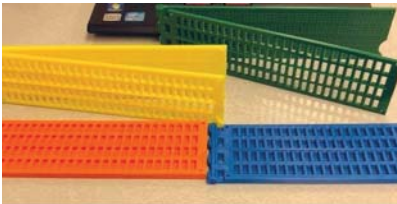

## Four Line 8 Dot Slate **N**

Traditional braille consists of six dots per cell, but six dots can only represent 64 unique patterns. Braille overcomes this limitation by letting two or more cells represent a single character. Preceding the symbol for a letter, for example, with a dot six makes that letter capital.

It is often desirable, especially in scientific or computer fields, to be able to represent a full character set, like ASCII in a one-to-one correspondence. That is where the 8-dot cell becomes important. With 8 dots to represent a character, you can make 256 unique patterns. APH offers a free file download that allows you to print your own slate on a 3-D printer.

**D-19920-ED FREE**

## Slateholder

Rugged vinyl carrying case will hold any APH slate. Second pocket holds two styluses or wooden erasers. Flap seals with hook/loop material. Belt loop and holes that fit a 3-ring binder.

Measures approx. 3 1/2 x 9 inches. Slates and styluses sold separately.

**1-00082-00 \$11.00**



APH.ORG

## Tactile Graphic Line Slate

This specially designed two-ended stylus is specially designed for the creation of tactile graphic displays by transcribers, teachers, and students. Use this lightweight slate to embellish tactile maps, graphs, charts, number lines, etc. The accompanying Instruction Booklet provides tips and techniques for using with various types of drawing media.

Recommended ages: 10 years and up.

1-00100-00 \$46.00



## Student Starter Pack

Basic braille materials packaged for students who are taking beginning braille classes. Includes 150 sheets of 8 1/2 x 11 inch manila transcribing paper, 150 sheets of 11 1/2 x 11 inch manila transcribing paper, a 4-line, 28-cell aluminum slate with Saddle Stylus, and a Cranmer abacus.

1-00350-00 \$81.00



## Braillewriting Dot by Dot

This kit focuses on beginning writing skills with braillewriters and slate & stylus. Braillewriting Dot by Dot kits are available in braille and print.

**Note:** It is recommended that a Swing Cell Compact, 6-78041-00, be used with this kit.

**Braille Teacher's Manual**

5-17400-00 \$63.50

**Print Teacher's Manual**

7-17400-00 \$79.00

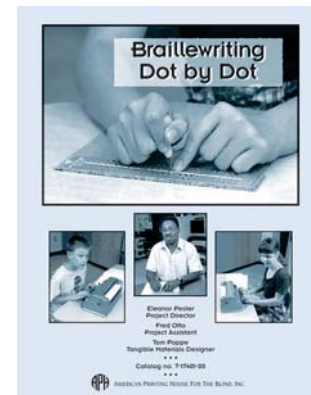

## Peg Slate

Designed to help teach beginning users of the braille slate. A frame is mounted with pegs that represent the braille dots in 10 braille cells. Push pegs down, then flip frame over to read the braille message. Instructions in print and braille.

Recommended ages: 6 years and up.

1-08830-00 \$22.00



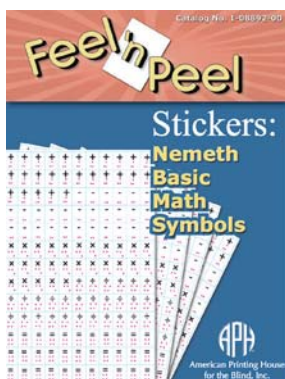
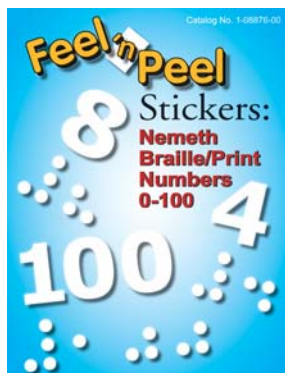

## Feel 'n Peel Products

These fun and educational tactile/visual stickers and sheets have a variety of uses, and are printed and/or embossed on durable plastic with bright, translucent colors.

### Braille/Print Capital Letters A-Z

Capital Letters A-Z are intended for the creation and adaptation of print capital letter materials for individuals who are blind and visually impaired.

These multi-use braille/print stickers are embossed on clear, durable plastic.

Recommended grades: Preschool and up.

1-08870-00 \$19.00

### Nemeth Braille/Print Numbers 0-100

These multi-use tactile stickers are printed and embossed on clear, durable plastic. Feel 'n Peel Stickers: Nemeth Braille/Print Numbers 0–100 are intended for the creation and adaptation of science and math-related materials.

Recommended grades: Preschool and up.

1-08876-00 \$24.00

### Basic Math Symbols

These multi-use braille/print stickers are embossed on clear, durable plastic. Separate UEB and Nemeth packages of the Basic Math Symbols are available.

Recommended grades: Preschool and up.

**Nemeth**

1-08892-00 \$33.00

**UEB**

1-08893-00 \$33 .00

### Feel 'n Peel Stickers I

Multi-use tactile/visual stickers for students and adults. Bright, translucent colors, durable plastic.

Recommended ages: 3 years and up.

1-08843-00 \$77.00



## Feel 'n Peel Stickers II

Multi-use tactile/visual stickers for students and adults. Bright, translucent colors, durable plastic.

Recommended ages: 3 years and up.

1-08864-00 \$96.00



## Feel 'n Peel Sheets Carousel of Textures

Multi-use tactile sheets are printed and embossed on clear, durable plastic.

Recommended grades: Preschool and up.

1-08863-00 \$96.00



## Tactile Connections: Symbols for Communication

This kit helps teachers create a tactile card system that is individualized for learners that have visual impairments or who are blind, have additional disabilities and/or lack a formal means of communication or literacy.

Recommended ages: 5 years and up.

1-08837-00 \$162.00



## SAM: Symbols and Meaning

A kit for students with visual and multiple impairments and pre-k children with visual impairments who are just beginning to use symbols. The SAM Guidebook provides strategies for developing a strong sensory foundation for concepts about people, objects, actions, and places so that symbols referring to them are meaningful.

**Note:** For the APH Intervention Continuum, APH recommends that learners use SAM and two other products in a certain order, see page 11 for more information.

1-08854-00 \$428.00





## Expandable Calendar Boxes

These closed-cell foam boxes that can be used singularly as an anticipation box, or in a grouping of two or more as calendar boxes. These boxes benefit students with disabilities that put them at risk for not understanding, participating in, or directing the events that surround them.

**White**  
1-08651-00 \$151.00

**Black**  
1-08652-00 \$151.00



## Calendar Box Stabilizer

Designed to rest on the majority of wheelchair trays, the stabilizer allows learning partners to present calendar boxes on a variety of surfaces (e.g., tabletops, floors) or hold them in the air before the student. The stabilizer is white on one side and black on the opposite side. For the visual ease of students—especially those students with cerebral/cortical visual impairment (CVI)—use the included white hook and loop material on the white side of the stabilizer and black hook and loop material on the black side.

1-08653-00 \$37.00



## STACS: Standardized Tactile Augmentative Communication Symbols Kit

Tactile symbol systems are valuable tools that aid learners with conversations about people, places, events, and ideas. This Kit helps learning partners (teachers, parents, peers, etc.) teach a beginning standardized vocabulary.

Recommended ages: All.

1-08815-00 \$696.00



## Graphic Art Tape

Includes three different widths of black, crepe-finish tape, 1/4, 1/8, and 1/16 inches, in 18-yard rolls with separate print and braille versions of a suggested uses sheet.

1-08878-00 \$38.00



## Aluminum Diagramming Foil for use With Tactile Graphics Kit

For creating masters of raised-line graphics. Foil has white paint on one side for drawing graphics beforehand in pencil or ink. Available in rolls or sheets. Roll is 11 inches wide and approximately 75 feet long. Sheets measure 11 x 11 inches, (30-pk).

### Sheets

1-04090-00 \$39.00

### Roll

1-04121-00 \$78.00



## Tactile Graphics Kit

The Tactile Graphics Kit is an extensive set of materials that allows teachers, transcribers, and mobility instructors to create custom raised-line maps, graphs, diagrams, and charts using a variety of point symbol tongs, areal pattern plates, and line drawing tools. Masters are embossed on heavy aluminum foil and can be reproduced on a vacuum-form machine.

1-08851-00 \$297.00



## DRAFTSMAN Tactile Drawing Board

A versatile tactile drawing board that is used in combination with special film and a stylus to create instant raised-line images. The board has a plastic frame that encases a double-layered rubber surface. Clamp a sheet of included drawing film onto the board and use the included stylus or a ballpoint pen to quickly draw a raised image.

1-08857-00 \$229.00



## Textured Paper Collection

This paper collection contains tactile colored sheets that can be cut out and applied to another surface for many purposes, such as tactile worksheets, areal patterns, storybooks, household items, etc.

1-03275-00 \$54.00



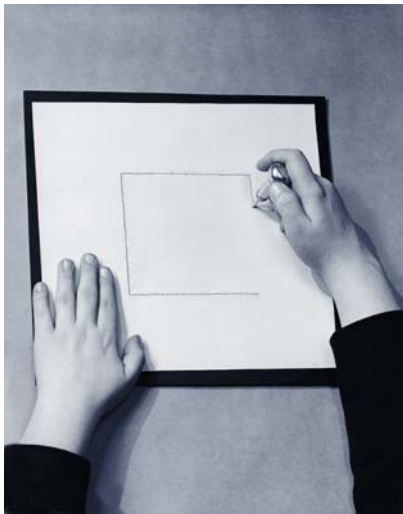

## Swail Dot Inverter

Construct simple diagrams, graphs, maps, etc., by embossing a series of single dots. Braille paper (sold separately) is placed on top of the 12 x 12 inch rubber pad. The special stylus allows dots to be embossed upwards by puncturing the paper on the down stroke and then pulling the dot upwards on the up stroke. Works best with Brailon® plastic braille paper, available in multiple sizes from American Thermoform, [www.americanthermoform.com](http://www.americanthermoform.com)

Recommended ages: 5 years and up.

1-03610-00 \$45.00

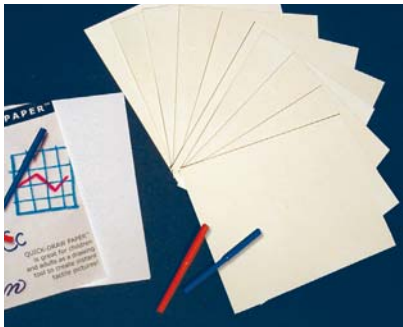

## Quick-Draw Paper

Create instant tactile graphics that are useful for a wide variety of art, orientation & mobility, diagramming, and educational activities. Simply draw on paper surface with a water-based marker and the lines will swell instantly and become tactile. Includes 10 sheets of Quick-Draw™ Paper, instructions in large print, and two water-based markers.

Recommended ages: 4 years and up.

1-04960-00 \$35.00



## IntelliTactiles Pre-Braille Concepts, Classroom Suite Edition

IntelliTactiles™ Pre-Braille Concepts Classroom Suite Edition helps develop skills such as tactile discrimination, shape recognition, and understanding of spatial/positional concepts. Includes seven tactile overlays that can be used alone or with the commercially available IntelliKeys® USB keyboard.

Recommended ages: 5 to 10 years.

1-08516-01 \$173.00

IntelliKeys keyboard not included.

## Word Associations Print/Braille Labels



Introduce children to the world of reading by using these large print/braille stickers! Consists of 12 sheets of self-adhesive labels containing common words. Includes 91 labels and a Manual in either large print or braille.

Recommended ages: 3 years and up.

**Labels with  
Large Print Manual**  
8-39050-00 \$59.00

**Labels with  
Braille Manual**  
6-39050-00 \$44.00



(Ball & bell not included)

## Card Chart Kit



Chart board measures 19 1/2 x 12 1/4 inches and has holes for hanging. Up to five cards can be inserted into each of six high contrast slots. Includes 90 blank cards, and a corner cut for orientation.

Recommended ages: All.

1-03550-00 \$48.00



## Individual Calendar Kit

Includes 12 brightly colored, embossed/bold line grid sheets - one for each month. Labels are marked in large print and in braille.

Recommended ages: 4 to 10 years.

1-18971-00 \$18.00

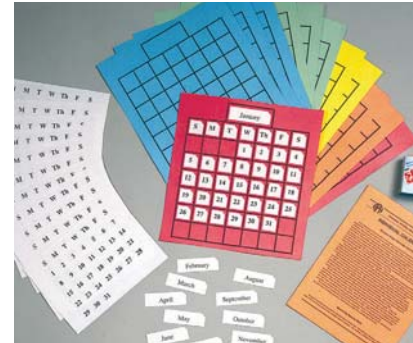

## Classroom Calendar Kit



Introduce children to concepts of measuring time; tracking left, right, top, and bottom; recording the weather; and recognizing and sequencing numerals.

Recommended ages: 4 to 10 years.

**English**  
1-18970-00 \$171.00

**Spanish**  
1-18973-00 \$174.00

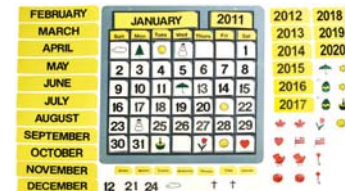



## Talking Typer (for iOS devices)

Comes with 35 built-in lessons at beginner and advanced levels. Teachers and parents can create new lessons, edit lessons, and assign lessons to individual students or groups. The app saves the results of each drill allowing students, teachers, and parents to monitor improvement.

The app can also be used with a refreshable braille display, making it accessible for students who are deafblind. Works with iOS devices running iOS 9.1 or later.

**Note:** Find detailed software purchasing instructions in the “How to Order” section page 181.

### Non-Quota (for individual purchase)

Available from the App Store:

<https://itunes.apple.com/app/id992103463>

**D-30021-AP** \$4.99

### Quota Order

**D-30021-APL** \$4.99

## Talking Typer™

A computer keyboard and typing training software that speaks and displays lessons on screen.

Includes drills, practice, and typing games, and is adjustable to the student’s level of skill and sight impairment.

Requires a PC running Windows® 7 or later.

Recommended ages: 6 years and up.

### CD-ROM

**D-03430-01** \$89.00

### Digital Download

**D-03430-ED** \$79.00

### Digital Download, Multiple Licenses

#### 25–49 users

**D-03430-ED1**

\$69.00/machine

#### 75–99 users

**D-03430-ED3**

\$55.00/machine

#### 50–74 users

**D-03430-ED2**

\$63.00/machine

#### 100+ users

**D-03430-ED4**

\$47.00/machine

## Learn Keys: Verbal Keyboard Feedback Software



A PC keyboard exploration and announcement program that gives you human speech feedback.

Requires a PC running Windows® 7 or later.

**Note:** Learn Keys is not a screen reader – it speaks keystrokes.

<b>CD-ROM</b>	<b>Digital Download</b>
<b>D-03410-00 \$14.95</b>	<b>D-03410-ED \$14.95</b>

## Braille Alphabet and Numbers Card

Intended to increase the awareness of braille among print readers, this card presents the alphabet, numbers, and limited punctuation signs in braille. A simple sentence in uncontracted braille is included, allowing for translation practice.

**Braille Alphabet and Numbers Card (100-pk)**  
**1-04020-00 \$8.00**

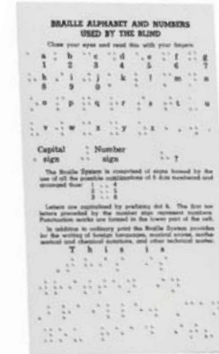

## APH Alphabet Card Folder

Designed to raise the awareness of braille among print readers, this card displays the braille alphabet, a sample of large print, and a brief history of APH. Measures 3 5/8 x 6 3/8 inches folded. Includes 100 cards. As a special service, educators may request up to five copies free by calling our 800 number.

Not available with Quota funds.

**1-04000-01 \$9.00**

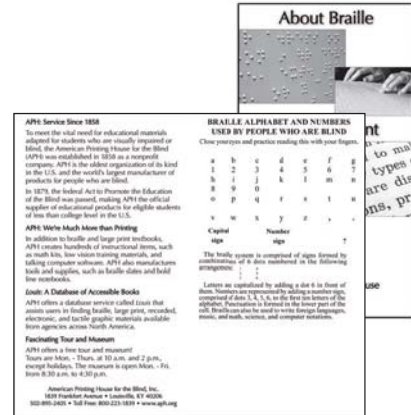

## Quick Check: Index of Literary Braille Signs

This booklet contains many of the common English braille contractions, including word signs, short-form words, punctuation, and composition signs.

<b>Braille</b>	<b>Print</b>
<b>5-35960-01 \$24.00</b>	<b>7-35960-01 \$10.50</b>

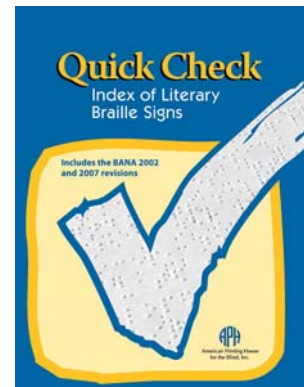



### ReadWrite Stand

Use this stand for both reading and writing tasks. Measures 18 x 14 1/8 inches and can be positioned in four distinct angles – 5° (at rest), 15°, 30°, and 45°. Weighs approx. 2 1/2 lbs.. It features two built-in handles, a low-profile clip for securing materials, and an LED book light.

Recommended ages: 5 years and up.

**1-03206-00** \$109.00



### ReadWrite Mini

Similar to the above ReadWrite, but smaller. Stand measures 10 x 11 1/2 inches and can be positioned in the same four distinct angles. Weighs approx. 1 1/2 lbs.

**Warning:** Adult supervision is required for adjusting the brackets for child use. DO NOT place fingers underneath the spring-loaded hinges of the uppermost bracket.

Recommended ages: 5 years and up.

**1-03207-00** \$103.00



### Grandstand: Portable Reading Easel

Easy to lift, carry, and lock into position. Folds up when not in use. Adjustable shelf may be raised and lowered to accommodate the height of the reader. Surface measures 15 x 14 1/2 inches.

Weighs only 2 1/3 lbs.

Recommended ages: 5 years and up.

**Yellow**

**1-03205-00** \$66.00

**Black**

**1-03204-00** \$64.00



### Desk Top Reading Stand

This reading stand is made of durable white plastic. It is portable and holds reading material at a proper position for low vision users.

Recommended ages: 8 years and up.

**1-03220-01** \$181.00





## Shafer Reading Stand

Adjustable, heavy-duty self-supporting stand for large print publications. Has a tripod base with a 42-inch shaft, and a 4-joint, adjustable swivel arm/book rack. Bookrack measures 16 x 11 1/2 inches. Swivel arm can be locked at any height along the shaft. All-metal construction, except for nonslip rubber feet.

Recommended ages: 6 years and up.

1-03230-00 \$326.00



## Swing Cell Compact

Helps students understand the relationship between the braille cell and the keys on a braillewriter. Internal storage of pegs.

Recommended ages: 5 years and up.

6-78041-00 \$62.00

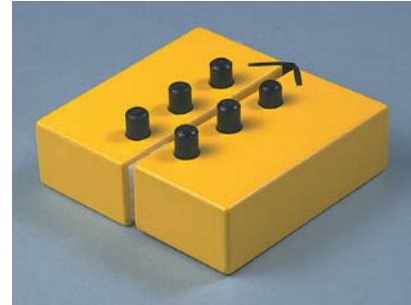

## Pop-A-Cell

A large-scale braille cell measuring 2 5/8 x 4 1/4 inches. Pop the durable plastic cell dots up or down to create various braille characters. Set of four colors and a Braille Alphabet and Numbers Card included.

1-17002-00 \$18.00



## Big Cell

An enlarged plastic braille cell model that allows a blind person to examine the shape of a braille cell. Helps beginning slate users learn where to put the stylus for various dot positions.

1-08820-00 \$10.00

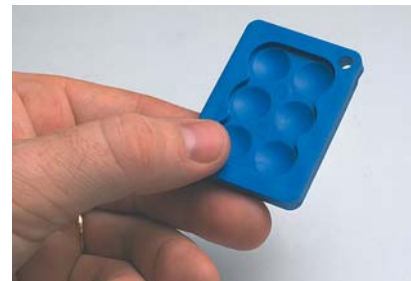



## Weekly Reader: Special Print/Braille Edition

A fun and educational publication for print readers who want to learn more about the way kids who are blind read and write. Cartoon characters help you learn about the braille code, Louis Braille, large print, and Talking Books. Regular print publication with samples of braille. Sold individually.

As a special service, educators may request up to five copies free by calling our 800 number.

Recommended ages: 8 years and up.

Z-SMWR97 \$1.00



## Touch and Tell

Classic set of braille reading readiness books. Volumes I and II introduce embossed hands and geometric forms. Volume III introduces braille dots.

Recommended ages: 5 to 6 years.

6-44670-00 \$99.00



## Teaching Touch

Helps parents or teachers encourage young children (4–7 yrs.) who are blind to become active explorers and readers of tactile graphics. The included booklet introduces various tactile graphics skills.

1-08861-00 \$69.00



## Setting the Stage for Tactile Understanding

This set of tangible items and activities assists young tactile readers in making the transition from the exploration of real objects to the interpretation of 2-D representations, both in thermoformed formats and simple raised-line illustrations. A 3-D house model aids in advanced understanding of scale and perspective.

Recommended ages: 5 years and up.

1-08853-00 \$209

## Flip-Over Concept Books

These books provide interactive, independent learning for young children as they build basic concepts and develop early tactile skills. The format of the books consists of tactile, full-color panels that can be turned until the child finds adjacent panels that continue a line or pattern, complete a sequence, build an image, and so on.

Recommended ages: 4 years and up.

### LINE PATHS

The goal is for the child to find three adjacent panels that continue the same type of line path (e.g., solid, dotted, double-dotted, etc.).

1-08831-00 \$88.00

### PARTS OF A WHOLE

The goal is for the child to find two adjacent panels that complete the whole picture as shown in the first (or left-hand) panel.

1-08832-00 \$63.00

### TEXTURES



The goal is to find three adjacent panels that are embossed with the same textured pattern. An assortment of textured vinyl panels is provided that the teacher/parent can select from to build a unique Texture flip-over book.

1-08829-00 \$125.00

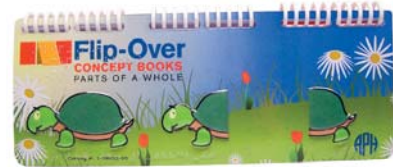
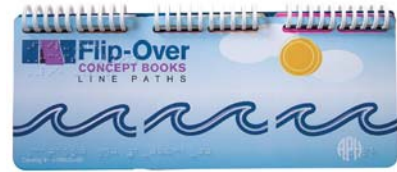



## Patterns Prebraille Program

Designed to prepare children before they begin braille reading. Helps build a child’s auditory, tactual, conceptual, and language skills. Emphasis in this program is on exposure to a variety of common childhood experiences.

6-78360-00 \$108.00



## Building on Patterns (BOP)

Building on Patterns is a systematic, comprehensive, and balanced literacy program designed to teach young children (through second grade) with visual impairments to read and write using braille.



### Prekindergarten Level

BOP Prekindergarten is the first level of the second edition of BOP, and its curriculum reflects best practices in braille literacy instruction, including lessons designed to build literacy skills related to listening, speaking, reading, and writing in preparation for kindergarten. It may be used as a stand-alone program, or as a supplement to regular preschool curricula.



APH recommends that the print children’s books and their braille transcriptions in the Student Kit stay with the student after using them during lessons to help them begin (or supplement) their own library. The print and braille books can also be sent home so family members can have their own interactive reading sessions with their child.



APH also highly recommends teachers use the electronic versions of the parent letters in order to tailor them to each student’s family.



Please visit the BOP overview and resources pages for more information on all levels of BOP.

**Note:** The font for the braille with shadow dots used in the letters is available to download as well.

### Features

- Includes 28 instructional lessons, each paired with a children’s book and a tactile storybook that supports lesson concepts through activities that involve tracking, simple reading, and understanding tactile graphics.
- Each lesson begins with learning objectives, and then includes sections on the following:
  - **Speaking and listening:** interactive read-alouds using high-quality children’s literature with

an emphasis on oral vocabulary and listening comprehension

- **Knowledge and concept development:** days of the week, weather, shapes, and other concepts relevant to the preschool curriculum
- **Phonological/phonemic awareness:** environmental sounds, rhyming words, syllables, and initial and ending sounds
- **Reading:** tracking skills, letter and number recognition, phonics, and independent reading of simple continuous text (tactile storybooks)
- **Writing:** practice exercises, modeled/interactive (shared) writing, and name writing
- A variety of tactile graphics
- Enrichment activities incorporating poetry, arts and crafts, music, and movement.

- Print and braille Teacher Kits are available.

**BOP Prekindergarten Student Kit Includes**

- Parent booklet
- Print Parent Letters (also available on the Prekindergarten website)
- Preschool Teacher Booklet\*
- Set of 27 Print Children’s Books
- Student Set of 28 Braille Children’s Books (includes one print-braille book)
- 28 Tactile Storybooks
- 4 Workbooks
- Worksheets Pack
- Manipulatives Pack
- Monitoring Charts and Reading Roundup Consumables (also available on the BOP Prekindergarten website)

**Print Teacher’s Kit Includes:** Quick Start Guide, Booklet, Manual, Reading Roundup and Reference Volume

**Braille Teacher’s Kit Includes:** Quick Start Guide, Booklet, Reading Roundup, Reference Volume and Teacher’s Set of Braille

**Note:** The 28-volume braille Teacher’s Manual is not included in this kit. It is available for free download from the APH Downloadable Manuals page.

**Teacher Kit Print**  
8-78534-00 \$265.00

**Student Kit**  
6-78530-00 \$859.00

**Teacher Kit Braille**  
6-78534-00 \$469.00



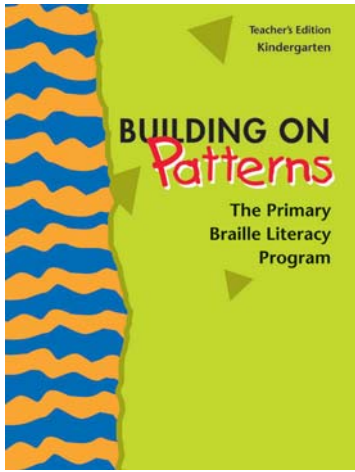

## Building on Patterns (BOP) Kindergarten, First Grade, and Second Grade

**Note:** BOP Kindergarten, First Grade, and Second Grade Levels each have a free UEB download of the Teacher Supplement from our manuals page for revised information.

### Kindergarten Level

“Building on Patterns is a systematic, comprehensive, and balanced literacy program designed to teach young children with visual impairments to read and write using braille.”

The series addresses vocabulary, fluency, comprehension, phonemic awareness (ability to hear and interpret sounds in speech), and phonics.

Kindergarten lessons include a selection to be read to the student, questions to discuss, and an activity for the child to complete.

Recommended ages: 4 years and up.

**Note:** Each student kit includes Posttest Consumables, Textbook Assessment Check-up Forms, set of 7 Student Textbooks, and a Color Me Book.

#### Teacher’s Kit Print (2 vol.)

8-78451-00 \$152.00

#### Braille

6-78451-00 \$152.00

#### Student Kit

6-78550-00 \$209.00

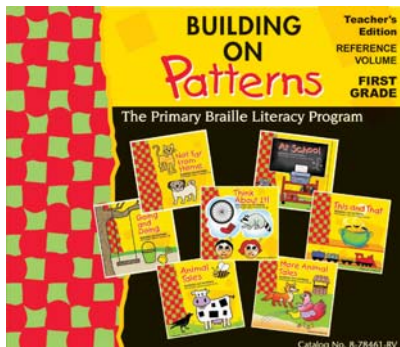

### First Grade Level

“Building on Patterns is a systematic, comprehensive, and balanced literacy program designed to teach young children with visual impairments to read and write using braille.”

BOP First Grade lessons require students to read selections themselves with emphasis on decoding skills, comprehension, and fluency. Creative writing, related to the reading selections, is included with each lesson. Spelling is based upon phonics skills. Worksheet packs, lesson monitoring sheets, and unit assessment packs are consumables and are available separately.

Recommended ages: 6 years and up.

**Unit 1, Not Far from Home**

**Student Kit**

6-78560-U1 \$139.00

**Teacher's Kit (Includes Reference Vol.)**

Print 8-78561-U1 \$99.00

Braille 6-78561-U1 \$99.00

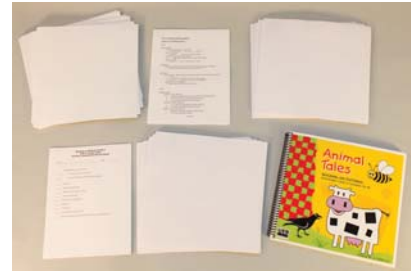

**Unit 2, Going and Doing**

**Student Kit**

6-78560-U2 \$139.00

**Teacher's Kit**

Print 8-78461-U2 \$65.00

Braille 6-78461-U2 \$69.00

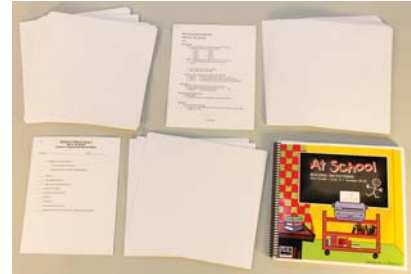

**Unit 3, Animal Tales**

**Student Kit**

6-78560-U3 \$139.00

**Teacher's Kit**

Print 8-78461-U3 \$59.00

Braille 6-78461-U3 \$59.00



**Unit 4, At School**

**Student Kit - UEB**

6-78560-U4 \$139.00

**Teacher's Kit**

Print 8-78461-U4 \$59.00

Braille 6-78461-U4 \$59.00



**Unit 5, This and That**

**Student Kit**

6-78560-U5 \$139.00

**Teacher's Kit**

Print 8-78461-U5 \$59.00

Braille 6-78461-U5 \$59.00



**Unit 6, More Animal Tales**

**Student Kit**

6-78560-U6 \$139.00

**Teacher's Kit**

Print 8-78461-U6 \$59.00

Braille 6-78461-U6 \$59.00

**Unit 7, Think About It!**

**Student Kit**

6-78560-U7 \$139.00

**Teacher's Kit**

Print 8-78461-U7 \$59.00

Braille 6-78461-U7 \$59.00



## Second Grade Level

Braille contractions are introduced from the beginning along with sound and letter associations. Expanded Core Curriculum (ECC) Skills such as using tactile graphics and technology are also included. Student materials are in UEB. BOP Second Grade includes more worksheets, part-word braille contractions, and other remaining literacy contractions and symbols along with the rules to use them. The curriculum also emphasizes syllables and multisyllabic words, and the effect of certain letter combinations on vowel sounds.

For optional map work, each lesson gives the foreign origin of at least one spelling word.

Recommended ages: 7 years and up.

Prerequisite: BOP First Grade or equivalent skills.

**Note:** Each student kit includes Lesson Monitoring Sheets, Assessment Check-up Forms, Student Textbooks, and Worksheets Pack. Unit 1 Teacher's Edition includes Reference Vol.

### UNIT 1, That's So Silly

#### Student Kit

6-78570-U1 \$179.00

#### Teacher's Kit

(Includes Reference Vol.)

Print 8-78571-U1 \$159.00

Braille 6-78571-U1 \$159.00

### UNIT 2, At Your Service

#### Student Kit

6-78570-U2 \$179.00

#### Teacher's Kit

Print 8-78471-U2 \$159.00

Braille 6-78471-U2 \$159.00

### UNIT 3, Family and Friends

#### Student Kit

6-78570-U3 \$179.00

#### Teacher's Kit

Print 8-78471-U3 \$159.00

Braille 6-78471-U3 \$159.00

### UNIT 4, Just for the fun of It

#### Student Kit

6-78570-U4 \$179.00



**Teacher's Kit**

Print **8-78471-U4** \$159.00  
 Braille **6-78471-U4** \$159.00

**UNIT 5, It's a Natural Thing**  
**Student Kit**  
**6-78570-U5** \$209.00

**Teacher's Kit**

Print **8-78471-U5** \$159.00  
 Braille **6-78471-U5** \$159.00

**UNIT 6, A Walk on the Wild Side**  
**Student Kit**  
**6-78570-U6** \$179.00

**Teacher's Kit**

Print **8-78471-U6** \$159.00  
 Braille **6-78471-U6** \$159.00

**UNIT 7, Celebrate Books**  
**(Includes 3 chapter books)**  
**Student Kit**  
**6-78570-U7** \$169.00

**Teacher's Kit**

Print **8-78471-U7** \$159.00  
 Braille **6-78471-U7** \$159.00

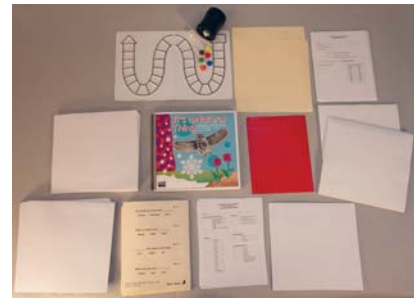

**Tactile Marking Mat**

A textured plastic sheet (17 x 13 1/2 inches) for use with included embossed-line Longhand Writing Paper or other thin paper. Mat's texture causes wax crayon marks to be tactile. Use for drawing, handwriting practice, and creating simple diagrams. Includes 100 sheets of paper.

Recommended ages: 3 years and up.

**1-03331-00** \$23.50

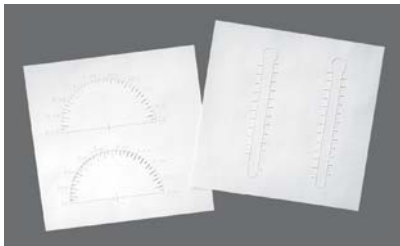

### Braille Transcriber's Kit: Math

Make braille transcription of elementary math books quicker with this collection of raised-line graphics. Master sheets contain five each of: rulers, number lines, protractors, unlabeled thermometers, and clock faces, as well as three sizes of low-relief graph paper. Master sheets can be thermoformed to provide multiple copies of figures.

**1-04100-00 \$24.00**

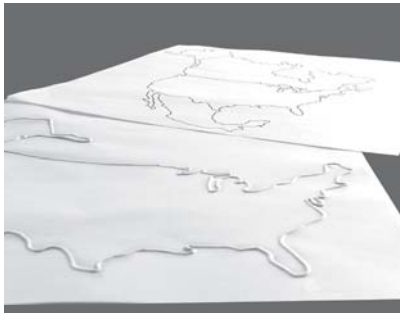

### Braille Transcriber's Kit: U.S. Maps

A collection of embossed and printed drawings found in history, geography, and social studies textbooks. The embossed sheets may be used as templates for thermoforming. Add to them with spur wheel lines, craft ink, glued-on textures, braille labels, and other tactile graphics materials.

Printed maps may be used as outlines for tracing or as masters for "swell paper" tactile graphics.

**1-04101-00 \$27.00**



### Braille Transcriber's Kit: Countries and Continents

The Braille Transcriber's Kit: Countries and Continents is a collection of embossed and printed outlines of maps commonly found in history, geography, and social studies textbooks.

The embossed sheets may be used as templates when you create tactile maps. Photocopy the images onto your capsule paper, add labels, lines, and symbols, and produce the raised image by running the graphic through the heating machine.

**1-04102-00 \$35.00**



### Embossed Pencil Writing Paper

Provides heavy raised lines to guide students or adults in handwriting. 22 lines per each sheet.

Measures 8 3/4 x 10 1/2 inches and is in pads of approx. 165 sheets.

**1-04560-00 \$12.00**



## Beginner's Writing Paper

This special paper helps students practice manuscript and cursive writing. Top of sheet is printed with a sample alphabet, followed by bold lines for practice. Measures 11 x 8 1/2 inches. Plain (no alphabet) is also available.

Recommended ages: 5 years and up.

**With Alphabet,  
Padded, 100 Sheets**

**Upper Case Manuscript**  
1-04910-00 \$8.00

**Lower Case Manuscript**  
1-04920-00 \$7.00

**Plain,  
Padded, 500 Sheets**

**8 1/2 Inches Wide**  
1-04731-00 \$19.00

**11 Inches Wide**  
1-04741-00 \$17.00



## APH SMART Brailer by Perkins

This mechanical brailer has a built-in screen and speaker that provides immediate feedback to a child or adult who is learning braille via text-to-speech, and a screen that displays SimBraille and large print of what is brailled in uncontracted or contracted braille.. Accommodates 8 1/2 x 11 inch paper and embosses up to 25 lines of 28 cells.

Recommended ages: 3 years and up.

**Warning:** Young children should be supervised during exploration and pre-braille activities.

The APH SMART Brailer by Perkins IS available with Quota funds.

1-00820-00 \$1,995.00 + shipping



## APH Light-Touch Perkins Brailer

This manual brailer has all of the great features of the classic Perkins Brailer but requires less pressure to depress the keys. Extended key design increases usability and comfort, and light gray keys provide contrast against the sapphire blue frame.

Recommended ages: 3 years and up.

**Warning:** Young children should be supervised during exploration and pre-braille activities.

APH Light-Touch Perkins Brailer is available with Quota funds.

1-00815-00 \$790.00





## Mailing Envelopes for Braille

Designed for mailing or storing brailled sheets up to 11 1/2 x 11 inches. White, blank envelopes with self-sealing flaps. Measure 12 1/2 x 12 1/2 inches. Will hold approximately 30 sheets.

**Envelopes (25-pk)**  
**1-04230-00 \$6.00**



## Covers for Braille Documents

Plastic covers measure 11 3/4 x 11 inches and are designed to bind 11 1/2 x 11 inch braille pages. May be bound with a 19-ring comb binding or twin loop binding. Will bind tractor-feed or manila 19-hole papers available from APH.

**Royal Blue**  
**1-04010-01 \$3.00**

**Clear Frosted**  
**1-04010-02 \$3.00**



## Braille Notebooks, 3-Ring

Made of heavy-duty board covered with vinyl. Two popular sizes: Azure Blue holds 8 1/2 x 11 inch braille paper and White holds 11 1/2 x 11 inch braille paper. Each holds approx. 100 sheets.

Azure Blue Notebook is not available with Quota funds.

**Azure Blue**  
**1-04320-00 \$19.00**

**White**  
**1-04380-00 \$9.00**

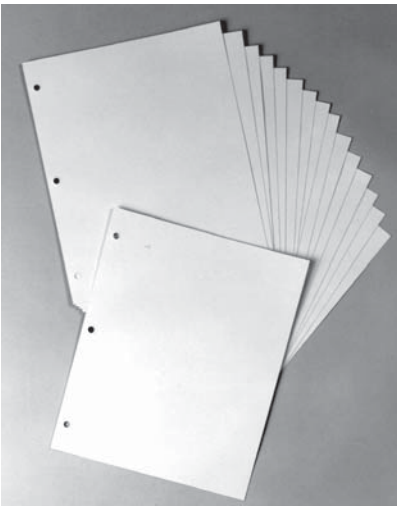

## Dividers for Braille Notebooks, 3-Hole Punch

Dividers will fit the Azure Blue or the White 3-Ring Braille Notebooks. Heavy manila stock with an extra 1/2 inch edge that can be brailled with the subject of the division. 15 dividers per pack.

**9 x 11**  
 (for Azure Blue Notebook)  
**1-04225-00 \$4.00**

**12 x 11**  
 (for White Notebook)  
**1-04226-00 \$4.00**

## Braille Paper

APH offers a wide array of braille paper for use with slates, braillewriters, computer braille embossers, and vacuum-form machines. Sheet quantities are approximate; all sizes in inches.

### White Braille Paper

This 80# paper is for use with braille slates and braillewriters.

**8 1/2 X 11**

**Unpunched R**

Now with 400 sheets

**1-04151-01 \$10.00**

**3-Hole Punch** 150 sheets

**1-04401-00 \$5.00**

**11 1/2 x 11**

**Unpunched** 150 sheets

**1-04221-00 \$6.00**

**3-Hole Punch** 110 sheets

**1-04471-00 \$5.00**

**3 3/4 x 5 3/4 6-Hole Punch**

Fits in Pocket Notebook

250 sheets

**1-04390-00 \$5.00**



### White Fanfold Tractor-Feed Braille Transcribing Paper

This low dust paper is designed to be used with computer-driven braille embossing devices. It has a smooth surface. Tractor-feed holes may be torn off. 90# paper.

**8 1/2 x 11**

**Unpunched** 500 sheets

**1-04137-01 \$24.50**

**3- and 19-Hole Punch**

500 sheets

**1-04138-01 \$24.50**

**11 1/2 x 11**

**Unpunched** 1000 sheets

**1-04139-01 \$50.00**

**3- and 19-Hole Punch**

1000 sheets

**1-04140-01 \$50.00**

### Manila Braille Transcribing Paper

Heavyweight 100# paper, for use with slates and braillewriters, holds dots well and can be used to create braille masters for vacuum-form machines.

**8 1/2 x 11**

**Unpunched** 500 sheets

**1-04530-00 \$20.00**

**3-Hole Punch**

500 sheets

**1-04660-00 \$20.00**

**11 1/2 x 11**

**Unpunched** 500 sheets

**1-04540-00 \$22.00**

**3-Hole Punch** 500 sheets

**1-04680-00 \$24.00**

**19-Hole Punch** 500 sheets

**1-04650-00 \$25.00**



## PermaBraille™ **R**

Now lighter weight, making it easier to braille and tool.

These 8 1/2 x 11 vinyl sheets provide a durable alternative to standard braille paper for a variety of tasks. Use for address and phone number lists, recipe cards, bulletin board displays, flash cards, tactile displays, and much more.

### Advantages of PermaBraille

- Use with either a braillewriter or slate and stylus
- Braille dots are durable and easy to read
- Waterproof and resistant to tearing
- Tactile graphic displays can be created by using a variety of cold-forming tools and specialized drawing tools
- Receptive to permanent markers for adding print labels/notes
- Create tactile graphic displays by using spur wheels (such as APH's Line-Drawing Tool Kit, 1-08851-01) or APH's Tactile Graphics Line Slate, 1-00100-00

**PermaBraille** (50-pk)

**1-08884-01** \$19.00



APH AMERICAN PRINTING HOUSE FOR THE BLIND, INC. Catalog No. 1-04825-00

## Bold Print Paper

Makes it easier for users with low vision to complete written tasks. All sheet quantities below are approximate; all sizes are in inches.

### Boldline Spiral Notebook

Looks like the type all students carry, but with bold line paper. 100 sheets of 8 1/2 x 11 inch paper, with 9/16 inch line space. Blue marble cover.

**1-04825-00** \$6.00



APH AMERICAN PRINTING HOUSE FOR THE BLIND, INC. Catalog No. 1-04826-00

### Collegiate Boldline Spiral Notebook

This notebook has more closely spaced bold lines than the Boldline Spiral Notebook. 75 sheets of 8 1/2 x 11 inch paper, with 7/16 inch line space. Black marble cover.

**1-04826-00** \$6.00

## Bold Line Notebook Paper

Has black lines printed on white paper with a left-hand margin. Two styles: in a pad with no punching or in loose sheets punched for a 3-ring binder. 500 sheets of 8 1/2 x 11 paper.

**Loose Sheets  
3-Hole Punch**

**7/16 inch line spacing  
1-04851-00 \$17.00**

**9/16 inch line spacing  
1-04861-00 \$17.00**

**Padded  
Unpunched**

**7/16 Inch Line Spacing  
1-04791-00 \$17.00**

**9/16 Inch Line Spacing  
1-04801-00 \$17.00**



## Green-Lined Writing Paper for Primary Students

Off-white paper printed with bold green lines, (300-pk).

**8 1/2 x 11**

**Unpunched  
3/4 inch lines  
1-04831-00 \$15.00**

**3-Hole Punch  
3/4 inch lines  
1-04869-00 \$17.00**

**7/16 inch lines  
1-04872-00 \$16.00**

**11 x 8 1/2**

**Unpunched  
3/4 inch lines  
1-04841-00 \$17.00**

**3-Hole Punch  
3/4 inch lines  
1-04881-00 \$22.00**



## Bold Line Letter-Writing Paper

This paper has bold, black lines printed on white paper without margin. 500 unpunched sheets per pad, 8 1/2 x 11 inch paper.

**7/16 Inch Line Spacing  
1-04811-00 \$17.00**

**9/16 Inch Line Spacing  
1-04821-00 \$17.00**

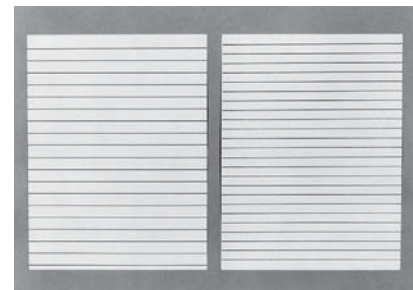



## Antique Ivory Opaque Paper

Ivory colored, unlined paper for good contrast – great for photocopying large print documents, (500-pk).

**8 1/2 x 11 R**  
**1-04501-01 \$16.00**

**11 x 17**  
**1-04500-00 \$25.00**

**11 x 14**  
**1-04500-05 \$23.00**

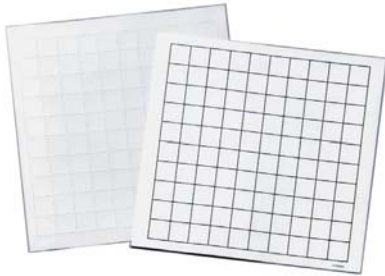

## Graph Sheets

Bold-line graph sheets have thick unit lines and thinner sub-unit lines. Embossed graph sheets have braille dot grids on manila paper.

**8 1/2 x 11**  
**Embossed (50-pk)**  
 7 x 10 grid  
 1 inch squares  
**1-04055-00 \$10.00**

**11 1/2 x 11**  
**Embossed (50-pk)**  
 13 x 13 grid  
 3/4 inch squares  
**1-04057-00 \$10.00**

**Bold Line (100-pk)**  
**Coordinate Axes**  
 15 x 20 grid  
 1/2 inch squares  
**1-04061-00 \$43.00**

10 x 10 grid  
 1 inch squares  
**1-04058-00 \$10.00**

31 x 40 grid  
 1/4 inch squares  
**1-04062-00 \$43.00**

**1-inch margin on 3 sides**  
 18 x 21 grid  
 1/2 inch squares  
**1-04059-00 \$10.00**

**For Bar Graphs**  
 15 x 20 grid  
 1/2 inch squares  
**1-04063-00 \$43.00**

**Bold Line (100-pk)**  
 10 x 10 grid  
 1 inch squares  
**1-04069-00 \$44.00**

10 x 13 grid  
 3/4 inch squares  
**1-04064-00 \$43.00**

7 x 10 grid  
 1 inch squares  
**1-04065-00 \$43.00**



## Low-Relief Embossed Graph Sheets

Great for teachers and transcribers to use in making charts and graphs. Grid is embossed on 11 1/2 x 11 inch, 80# braille paper with margins, (25-pk).

### 19 x 19 Grid

0.4 inch squares

1-04046-00 \$5.45

### 17 x 16 Grid

1/2 inch squares

1-04047-00 \$5.45

### 13 x 12 Grid

5/8 inch squares

1-04048-00 \$5.45

### 11 x 10 Grid

3/4 inch squares

1-04049-00 \$5.45

### 20 x 20 Grid

1/2 inch squares, X-Y axis

1-04045-00 \$8.00

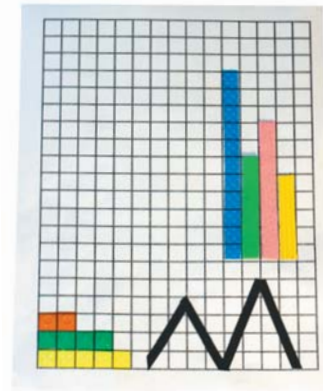

## Bold-Line Tactile Graph Sheets

These graph sheets combine tactile and print, which expand APH's graph sheet collection previously available only in embossed paper or print-only packages. Label and embellish the graph sheets using a variety of methods (e.g. braillewriter, line-embossing tools, tactile stickers, graphic art tape, etc.).

1-04080-00 \$49.00



## Pocket-Size Notebook, 6-Ring

Bound in imitation leather. Will hold approximately 50 sheets of 3 3/4 x 5 3/4 inch braille or bold line paper (not included). Has a pocket designed to hold a slate and a cloth page marking strip. Stylus can be tied to the cloth strip. Tabs make this notebook an organizer (sold separately).

1-04280-00 \$20.00



Slate and stylus sold separately.

## Krebs' Binder, 19-Ring

Made of heavy-duty board covered with imitation leather. Holds 11 1/2 x 11 inch 19-hole punched braille paper, 105 sheet capacity. Binder ring assembly consists of a metal back plate, metal rings, and a locking pin.

1-04260-00 \$42.00





## Spiral Pocket Notebook

Each notebook contains 50 pages of 80 pound white braille paper. Spiral binding makes it easy to handle. Measures 3 x 5 1/2 inches. Sheets are perforated and measure 3 x 5 inches when removed. Works easily with APH's Janus Slate.

**Spiral Pocket Notebook (6-pk).**

**1-04301-00 \$26.00**



## Floppy Braille Binders

Durable plastic 3-ring binder designed to hold 11 1/2 x 11 inch braille sheets. Flexes to fit easily into a backpack. Includes 3 binders, 1 each: green, blue, yellow with an inside pocket.

**1-04295-00 \$16.00**



## Braille Pocket Folders

Will hold 11 1/2 x 11 inch braille sheets. Has slant-cut pockets. Punched for 3-ring binder. Made of durable, flexible plastic. Includes three folders, 1 each: green, blue, and yellow.

**1-04294-00 \$15.00**



## Super-Sized Folders

These folders are made of a semi-rigid polyblend plastic. They measure 12 x 11 1/4 inches with a depth of 3/4 inches, allowing full 11 1/2 x 11 inch braille sheets to fit. Part of the braille page remains uncovered so that the contents of each folder can be quickly scanned, 1 each: green, blue, and yellow.

**1-04296-01 \$15.00**



## Plastic Binder Envelopes for Braille

These envelopes have a side tab that is 3-hole punched for use in a 3-ring binder and a flap that opens from the top and is held closed using three hook & loop coins. Accommodates up to 20+ sheets of braille, 1 each: green, blue, and yellow.

**1-04297-00 \$29.00**

# Visual Efficiency and Low Vision Section Index

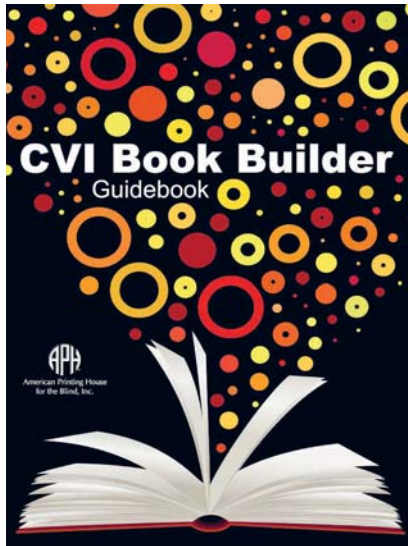

Armadillo Army Software .....	134	Seated Parquetry Set .....	126
Bright Line Reading Guide .....	126	See Like Me: Low Vision Simulators <b>N</b> .....	123
Colored Shape Cards .....	132	Spinner Overlays for Light Box .....	128
CVI Book Builder <b>N</b> .....	122	Swirly Mat Sets .....	132–133
CVI Complexity Sequences.....	133	Teach Me to See Video .....	125
Decision Making Guide <b>N</b> .....	123	Teen Scene: Portraits of Success Video .....	125
Digital Light Box Artwork .....	132	Termite Torpedo Software .....	134
ENVISION I and II .....	125	Toodle Tiles Software .....	134
Explorer Bright Ray .....	124	Tri-fold Board.....	127
Familiar Object Pictures .....	132	UltraLens .....	127
Increasing Complexity Pegboard.....	124	Variable Beam Flashlight Kit .....	124
Individual Study Screen.....	124	Video Mag HD .....	126
Invisiboard .....	127		
Light Box, Mini-Lite Box, Materials .....	128–130	<b>Visual Efficiency and Low Vision</b>	
Lighting Guide Kit <b>R</b> .....	131	<b>Related Products</b>	
Match Sticks .....	126	All-in-One Boards .....	91
Mini-Lite Box Overlays <b>N</b> .....	128	Bold Line Paper.....	116–117
Plexiglas Spinner and Spinner Patterns .....	131-132	EZ Track Products.....	158
Plexiglas Blocks.....	131	Fine Motor Development Materials .....	35
Pegs and Pegboard.....	131	Reading Stands.....	102–103
		Sensory Learning Kit (SLK).....	34

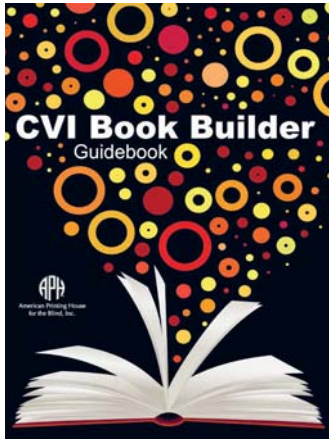

## CVI Book Builder

This book making kit is designed to create individualized books for children diagnosed with Cerebral/Cortical Visual Impairment (CVI).

Children diagnosed with CVI frequently have difficulty in understanding objects, pictures, and letters presented against a complex background. CVI Book Builder provides materials for parents and teachers to build books specifically for their reader. The kit provides a variety of black pages and black binders to use as low complexity backgrounds against which to present familiar items, photos, and letters/words.

### Features

- Builds a connection between an actual object and a photo of that object, teaching that photos (symbols) have meaning.
- Takes advantage of natural learning opportunities; i.e. at toothbrushing times, present the child's toothbrush and describe it while letting them explore, and then proceed with brushing his teeth. Attach the toothbrush to a black needlepoint canvas page, present it next to the photo on a polyblend page.
- Once the child demonstrates understanding of the photos in the book, you can begin to expand learning by exploring size, direction, colors, and other developmental concepts.
- When understanding that symbols/pictures have meaning, they may be ready to explore letters/words.
- Additional book ideas are listed in the guidebook.

### CVI Book Builder Collection Includes

- 3 Small, black binders
- 1 Large, Black binder
- 8 Black fabric pages for hook and loop attachments
- 8 Black magnetic pages
- 16 Black polyblend pages
- 10 page protectors
- Magnetic strips, adhesive-backed
- Regular profile black hook and loop adhesive-backed coin sets
- Brailleable clear plastic label material
- 50 Plastic banding ties
- Large print guidebook

1-08825-00 \$279.00

## See Like Me: Low Vision Simulators

These simulators are standard safety glasses that have been fit with inserts to mimic common eye conditions.

These simulators are designed to present a version of each specific eye condition listed below. These simulators are different from others on the market because they show the color changes that are often present in certain eye conditions as well as differences in vision that often occur between the two eyes.

No two eye conditions are the same and no two eyes are exactly the same, especially those that have disease, injury, or congenital anomaly. The See Like Me Low Vision Simulators cannot mimic any person's exact vision; instead, they give a general sense of what it is like to function with low vision that stems from a particular condition.

### See Like Me Low Vision Simulators Eye Conditions

- Cataract
- Glaucoma
- Diabetic Retinopathy
- Macular Degeneration
- Retinitis Pigmentosa
- Detached Retina
- Hemianopsia
- High Degree Myopia

Recommended ages: 12 years and up.

1-08053-00 \$149.00



## Decision Making Guide

This guide provides a parent, teacher, or other professional with an easy formula to help determine the correct print size for a student's eye function.

Decision Making Guide: A Guide to Print Size Selection is a quick guide to help determine the correct print size for a student's unique visual functioning. The estimate is reached as part of a learning media assessment with the use of word, sentence, and passage reading charts to arrive at print sizes needed for various tasks.

### Includes

- Bailey-Lovey Charts (Word Reading, Sentence Reading, Passage Sample, and Pre-Primer Sentence Reading)
- Large print guidebook

7-96156-00 \$51.00

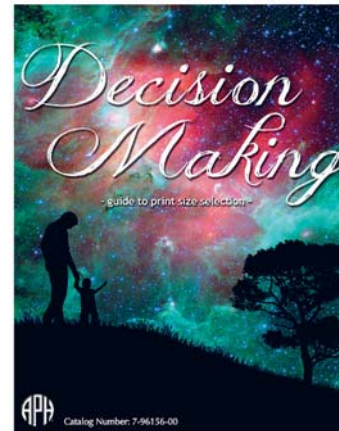



## Explorer Bright Ray

This head-worn LED lamp helps adults and students with many activities. Features 3 light intensity settings, adjustable angle and head straps, very low energy usage, unbreakable lens, and water resistant. Included book tells reader everything they need to know about Light Emitting Diodes (LEDs).

**1-08943-00** \$79.00



## Increasing Complexity Pegboard

The Increasing Complexity Pegboard was created for children with visual impairments, including those diagnosed with CVI. Paired with diagnostic teaching strategies, the pegboard set helps to determine and support the child's color, lighting, movement, and complexity needs.

**Note:** The APH Tactile Graphic Image Library (TGIL) has access to 3-D printing files, allowing additional pegs to be printed on your own 3-D printer.

**1-08160-00** \$169.00



## Individual Study Screen (ISS)

Allows low vision students to view films and slides. A rear-projection technique enables one student to get as close to the screen as he/she requires. Constructed of tough plastic, screen measures 13 x 10 1/2 inches. Image is projected on a frosted plastic insert.

Recommended ages: 6 years and up.

**1-03300-00** \$22.00



## Variable Beam Flashlight Kit

Designed to help students develop visual awareness and tracking skills. Kit includes: Instructions and activities, two variable beam flashlights, two sets of five translucent and four transparent color lenses, Color Beam Book (Large Print with CD), and AAA batteries.

**1-08390-02** \$66.00

## Teach Me to See

This DVD gives practitioners guidance on developing and carrying out activities that are functional and have meaning to each child. Listen to experienced teachers talk about orientation and mobility skills, immersive learning, visual development, and choice-making for their young students.

**1-30044-DVD \$10.00**

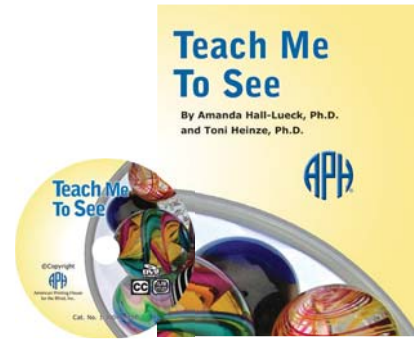

## Teen Scene: Portraits of Success Video

Starring four Kentucky teenagers with low vision, this 39-minute video will make you laugh, warm your heart, and make you feel as though you know these teens! It's all about being successful, self-advocating, dating, playing sports, or achieving in school or on the job. Closed captioned.

**1-30011-DVD \$25.00**



## ENVISION

The ENVISION training program uses stories and activities about Emmy the Emu and other high-interest characters to teach students skills such as tracing, tracking, and scanning. Enrichment activities and objectives for each lesson, as well as reports to the clinician are included.

**ENVISION I with Telescope Array for Distance Devices** – simulates standard street signs, addresses, international symbols, and familiar objects.

**1-08551-00 \$919.00**

**ENVISION II with Magnifier Array for Near Magnification Devices** – simulates graphics and print used in textbooks and literature.

**1-08552-00 \$755.00**



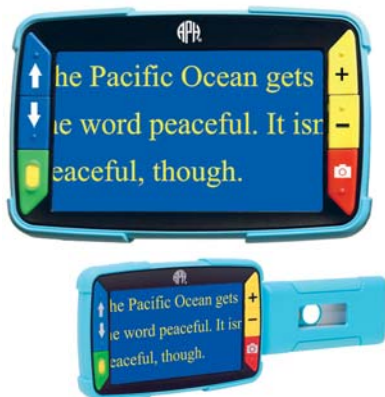

## Video Mag HD

American Printing House for the Blind and Freedom Scientific partnered to develop the Video Mag HD, a durable, kid-friendly handheld high definition video magnifier.

Video Mag HD combines a high-definition camera with a rugged, lightweight body. It's auto-focus HD camera can magnify from 2x to 13x. 4.3-inch LCD screen. Supports five default color modes and 15 additional contrasting color modes.

Available with Federal Quota funds!

**1-03914-00** \$499.00 + shipping



## Match Sticks

This game is designed to provide children in Phases II and III of the CVI Range Assessment\* with a matching activity that is fun and entertaining and that helps develop vision skills.

\*Roman-Lantzy, C. (©2007). Cortical Visual Impairment: An Approach to Assessment and Intervention. American Foundation for the Blind Press.

Recommended ages: 5 years and up.

**1-08157-00** \$104.00



## Bright Line Reading Guide

Place guide over text to highlight, eliminate glare, and promote maximum contrast. Bright Line Reading Guide is 10 inches long, but can be cut to any size and three-hole punched for placement in a binder. Each pink or yellow guide comes in a vinyl protective pouch.

**Yellow** (2-pk)  
**1-03060-00** \$11.00

**Pink** (2-pk)  
**1-03061-00** \$11.00



## Seated Parquetry Set

Stimulates use of residual vision and helps to develop visual efficiency. Students master visual discrimination, eye-hand coordination, part/whole concepts, matching skills, and visual memory skills. Uses recessed form boards that can be raised to the eye while holding the parquetry pieces in place.

Recommended ages: 3 years and up.

**1-03650-00** \$229.00





## UltraLens

Black lights, which generate both UV and blue light, are sometimes used in vision development activities. UltraLens glasses screen out 100% of UV and blue light while still allowing the wearer to see the “glow” of materials as they fluoresce. A soft case is included with each UltraLens.

**Note:** Filters like the UltraLens should always be worn by both the practitioner and the child during exposure.

### Infant With Headstrap

1-08177-00 \$33.00

### Jr. With Headstrap

1-08176-00 \$33.00

### Jr. Clip-On

(for child who wears glasses)

1-08178-00 \$23.00

### Adult

(worn alone or over glasses)

1-08175-00 \$11.00



## Invisiboard



Block out distractions for students with CVI. This portable, lightweight 48 x 30 inch tri-fold board eliminates visual clutter with a solid white, slick material on one side and a solid black, hook-and-loop material on the other. Includes carrying case and print/braille manual.

1-08541-00 \$152.00

## Tri-Fold Board



This board measures 37 x 24 inches and is covered with hook-and-loop material that can be used in combination with many existing APH hook-and-loop material-backed pieces, as well as with commercially available OR teacher/parent-made manipulatives. Two 3/4-inch nickel plated D-rings are riveted in the top for easy hanging.

1-08859-00 \$66.00



**Note:** Tic-Tac-Toe Accessory kit and Invisiboard sold separately.



**Note:** Pieces shown are not included with the board. The Tri-fold Board is included as a component in Azer's Interactive Periodic Table Study Set.



## Mini-Lite Box, Overlays

Mini-Lite Box Overlays enable parents and teachers to build visual complexity and customize lessons according to the needs of their learner.

Used for instruction or assessment in color and shape identification, and counting, parents and teachers can individualize their lesson(s) by adding layers of Mini-Lite Box overlays according to each student's level of visual complexity.

### Includes

- Translucent overlays in three colors and three shapes (red, blue, yellow; circles, squares, triangles)
- Translucent overlays with black horizontal stripes, vertical stripes, and rainbow stripes
- Translucent solid color overlays in pink, orange, and purple
- Large print guidebook

**1-08659-00** \$109.00

## Spinner Overlays

Designed to support the individual needs of learners with Cortical Visual Impairment (CVI) or low vision, Spinner Overlays can be adapted and layered for many purposes. They use light, movement and increasing levels of complexity and may be customized by creating patterns with the included pre-cut stickers, or with commercially available stickers.

**Warning:** Choking Hazard—Small Parts. Not intended for children ages 5 and under without supervision. Seizure Hazard—Use of this product can simulate flashing lights. Adults supervising learners prone to seizures brought on by flashing lights are advised to use this product with caution.

**1-08692-00** \$311.00

## Light Boxes

When they are used with unique sets of materials, APH's Light Box and Mini-Lite Box help develop awareness of light, color, and objects and assist in the instruction of tracking, scanning, eye-hand coordination, visual discrimination, and visual perceptual skills.

Recommended ages: All.



Overlays sold separately



### Light Box

The Light Box has a lighted translucent white work surface, providing a high contrast background for opaque materials and a source of illumination for colored transparent and translucent items. Includes dimming control, and can be used flat or tilted at three angles. Included adapter accepts power from 110VAC to 220VAC.

**Please Call Customer Service**

### Mini-Lite Box

APH's Mini-Lite Box is smaller, lighter, and more affordable than the Light Box. The Mini-Lite box is usable at a student's desk or on his/her lap. Individual items from Light Box Materials Levels I, II, and III can be used with the Mini-Lite Box. An optional Mini-Lite Box Carrying Case is available. Also available separately are Mini-Lite Box Transparent Overlays which may be used to promote light awareness; improve contrast and visibility; and introduce color matching.

**1-08661-00 \$135.00**





## Light Box Materials and Activity Guides

The Light Box Materials include Activity Guides. These guides have sections on CVI, references to products, and increased accessibility. Guides are available in English and Spanish. Activity Guides for all three levels may include a number of Activity Sheets.

**Note:** Most Light Box Materials in all levels can be used with the Mini-Lite Box.

### Level I

Materials help teach basic visual skills, eye-hand coordination, and simple matching skills.

Recommended ages: Birth to 4 years.

**1-08670-00** \$438.00

### Level II

Helps teach matching and identification skills, part-whole relationships, sequencing, pattern duplication, spatial relationships, and visual memory skills.

Recommended ages: 3 to 5 years.

**1-08680-00** \$854.00

### Level III

Help students develop: prewriting and handwriting, matching and sorting, recognition and identification, spatial relationships, visual memory, sequencing, figure-ground discrimination, visual closure, and part-whole relationships.

Recommended ages: 4 to 6 years.

**1-08690-00** \$979.00

## Lighting Guide Kit **R** PARTS

The Lighting Guide Kit includes the Better Vision Lamp, now enhanced with a 2700K LED bulb and two-level brightness, and a large print booklet, LEDs - presents information, based upon latest research, about light and its physical properties, as well as how to decide what kind of light is best for a given student or situation. Perfect task lighting for low-vision users of all ages

**Note:** The Better Vision Lamp is not available separately.

**1-08941-01** \$159.00



## Plexiglas® Spinner and Spinner Patterns

Spinner, made of clear plastic, is used with overlays to create highly contrasting, moving patterns to stimulate visual awareness and encourage attention and visually directed reaching. Suction cup feet hold the spinner base in place.

**1-08664-00** \$88.00

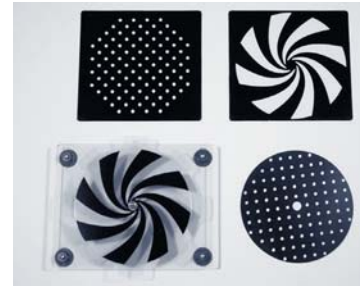

## Plexiglas Blocks

Colored transparent and translucent geometric shapes in two sizes to create displays for attracting visual attention; encouraging visually directed reaching; matching by shape, size, and color; and for introducing spatial relationships. Thirty pieces in six colors and three shapes: circle, triangle, and square.

**1-08663-00** \$43.00



## Pegs and Pegboard **CVI**

Fosters eye-hand coordination, awareness of spatial relationships, and matching and sequencing skills. Includes 64 colored translucent pegs in three shapes and five colors for use in or out of the included 6 x 6 grid pegboard.

**1-08665-00** \$179.00

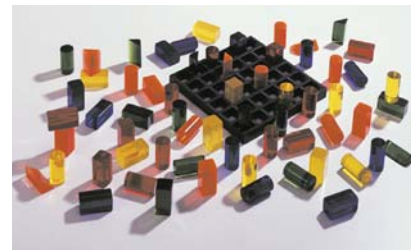



## Familiar Object Pictures CVI

Colored transparent pictures of 15 household objects are provided in pairs (30 cards total) for matching and identification. Pictures are silk-screened on clear 6 x 6 inch plastic stock.

**1-08666-00 \$82.00**



## Colored Shape Cards

Colored transparent and translucent pictures of geometric shapes for identification and matching by shape, color, and size. Thirty cards provided: two each of nine shapes, some in three sizes. Shapes are silk-screened on clear 4 x 4 inch plastic stock.

**1-08667-00 \$54.00**

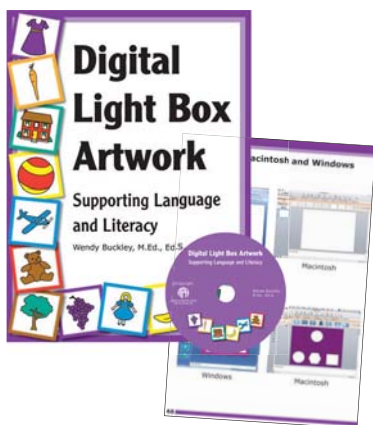

## Digital Light Box Artwork CVI

Use Digital Light Box Artwork (DLBA) with your software to provide extension activities for the Light Box and/or provide familiar images for children who transition from Light Box to computer activities.

APH has digitized the individual art pieces from the APH Light Box Materials for use on your computer! The large print instruction guide teaches how to create activities. The artwork can be used with many commercially available authoring programs. Artwork files are in .png format. Includes a large print guidebook with CD-ROM.

**1-08691-00 \$40.00**



Mini-Lite Box  
sold separately



## Swirly Mat Sets CVI

Durable, non-toxic Swirly Mats come in two sets: Cortical Visual Impairment (CVI) and Functional Vision Assessment (FVA). The mats in the CVI set are less complex. The mats in the FVA set are more complex. Both mats can be used for locating, tracking, color discrimination, etc. Try them with APH's Mini-Lite Box (sold separately) for a different effect. Each set includes white background mat, print and braille instructions, and a plastic carrying case.

**CVI**  
**1-08153-00 \$61.00**

**FVA**  
**1-08154-00 \$55.00**

**\*Note:** Always provide adult supervision when using Swirly Mats/Swirly Mats II with young children. Mats are completely sealed; however, in the event of a rupture, small pieces inside the mats may present a choking hazard. Liquids are non-toxic but will stain. Use caution.

## Swirly Mats II

Swirly Mats II CVI™ have added elements for more complexity; Swirly Mats II FVA™ have added elements and different color choices. Try them on one of the durable tabletop mats included in the kits.

**\*See note of caution at the bottom of page 130.**

**CVI**  
1-08158-00 \$84.00

**FVA**  
1-08159-00 \$86.00



## CVI Complexity Sequences Kit

Includes cards that present sequences of images designed to refine the ability to identify a target in the presence of increasing amounts of background information. These cards may be used individually or as a sequence and should be presented against a black or plain, light-absorbing background.

Recommended grades: Preschool and up.

1-08156-00 \$62.00

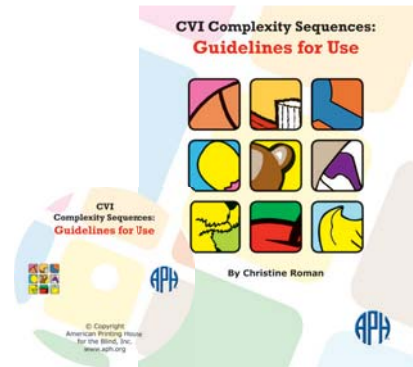

## CVI Complexity eBook and Interactive Cards

CVI Complexity Sequences eBook and Interactive Cards has the same information and content as the CVI Complexity Sequences Kit. The eBook edition also includes an interactive feature: successfully touching the target image results in an audio response that acknowledges the action.

In addition to tablet devices, CVI Complexity Sequences eBook and Interactive Cards can be used on Macs and on PCs. At this time, the audio feature is not supported by all eReaders. To determine if an eReader supports the interactive feedback, ensure it supports EPUB 3.x format or newer.

Recommended grades: Preschool and up.

**Note:** This publication cannot be ordered directly using the APH Shopping Site, please contact our customer service department on how to purchase. For more information about epub files, see page 182.

**Quota or Non-Quota**  
D-03610-ED \$9.95

**Non-Quota**  
**Available from iTunes**  
**or iBooks**  
D-03610-ED \$9.95



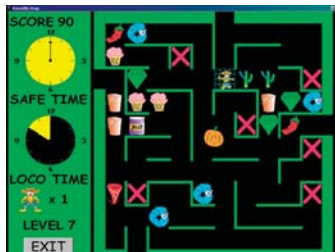

## APH Software for Windows System Requirements

Requirements to run: PC running Windows® 7 or later.  
Software requires a sound card, speakers, and  
CD-ROM drive.

### Armadillo Army™

The game has bright, large graphics, as well as meaningful sound elements. Low-vision users practice lateral eye movements, vertical eye movements, searching skills, timing skills, visual discrimination skills, peripheral detection skills, eccentric viewing skills, and eye-hand coordination.

**CD-ROM**  
**D-03400-00 \$49.00**

**Digital Download**  
**D-03400-ED \$39.00**

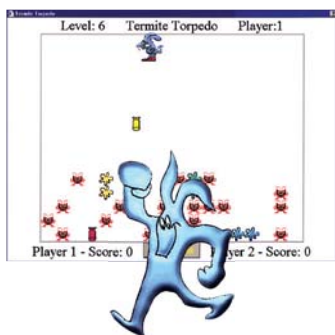

### Termite Torpedo™

An educational game that gives students with low-vision practice in the visual skills of locating, fixating, tracking, aligning, and following. Termites are eating their way through Woodville! Only you can save the city by clearing the playing field of 12 levels of termites!

**CD-ROM**  
**D-03470-00 \$39.00**

**Digital Download**  
**D-03470-ED \$39.00**

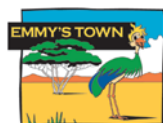

### Toodle Tiles: Emmy's Town™

Based on the matching game of Mahjong, the object is to clear away matching tiles and pave the way for the new mayor of Emuville. Features bright, high-contrast colors and simple designs in five different tile sets.

**CD-ROM**  
**D-00300-00 \$49.00**

**Digital Download**  
**D-00300-ED \$39.00**



# Orientation and Mobility Section Index



Crossings With No Traffic Control <b>N</b> .....	136	DRAFTSMAN Tactile Drawing Board .....	97
Denver the Guide Dog Video .....	139	Fine Motor Development Materials .....	35
Echolocation and FlashSonar .....	137	Geometric Forms .....	57
Miniguide US .....	138	Moving Ahead Series .....	32
Nearby Explorer .....	137–138	Portable Sound Source .....	81
O&M		Reach & Match .....	21
Family Booklet Software .....	139	Reclaiming Independence Video .....	155
Trivia (Alexa Skill <b>N</b> and Google Action) .....	139	Rolling Right Along Construction Kit .....	41
Tactile Graphics .....	139	Sensory Cylinder Set .....	38
For Wheelchair Users w/VI .....	140	Small, Medium, and Large Circles Sets .....	38
Picture Maker .....	141	Sound Matching Board I & II .....	37
Step-by-Step .....	140	Sunu Band .....	152
Tactile Town .....	137	Tactile Treasures .....	35
Teaching Street Crossing .....	136	Textured Pegs .....	36
<b>Orientation and Mobility</b>		Textured Sorting Circles and Shapes .....	55
<b>Related Products</b>		Touch and Tell .....	104
Calendar Kits .....	99	Touch ‘em All Baseball .....	161
		TREKS: Game of Compass Directions .....	163

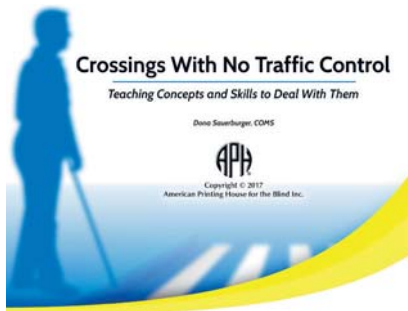

## Crossings With No Traffic Control **N**

This software provides simulation experiences and information that help instructors teach students to analyze situations at street crossings where there is no traffic control, including recognizing when they don't have enough warning of approaching vehicles ("Situations of Uncertainty").

Instructors will take an active role in their students' learning, providing direct supervision and dynamic engagement. The product includes additional hardware to aid in this effort. Student content is narrated throughout the software; instructor content is not read aloud.

Crossings With No Traffic Control contains a self-updating feature that activates automatically once connected to the internet.

**Important Liability Notice:** The American Printing House for the Blind, and author Dona Sauerburger, COMS, offer O&M Specialists with this product to help students learn the concepts and skills necessary to analyze and negotiate crossings that have no traffic control. Before using this product with students, instructors must read the first section in Chapter One: How to Use this Product.

1-18988-00 \$62.00

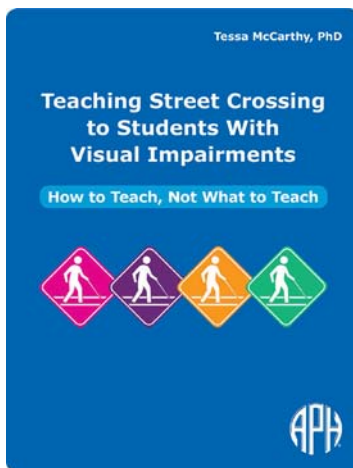

## Teaching Street Crossing to Students With Visual Impairments

How to Teach, Not What to Teach provides information about teaching various components of street-crossing skills at appropriate ages/developmental levels; sequencing skills and environments; and using appropriate pedagogical strategies to enhance effectiveness of street-crossing instruction. Practical case examples and vignettes throughout the manual apply concepts to real-world scenarios.

8-75978-00 \$27.00

## Echolocation and FlashSonar

This large print guidebook, written by Daniel Kish and Jo Hook, provides instructional strategies for teaching use of echolocation as a method of gaining information about space and objects/environmental features in the world around them.

Although Echolocation and FlashSonar works well as an instructional manual for O&M specialists, it can also be used by adults who are blind and visually impaired who are working independently. An extensive list of references and resources is provided for the reader.

**Warning:** FlashSonar skills should be used along with a human guide, dog guide, or cane.

8-75975-00 \$77.00

### ECHOLOCATION AND FLASHSONAR DANIEL KISH JO HOOK



## Tactile Town: 3-D O&M Kit

Tactile Town provides an interactive, 3-D model to help teach spatial concepts and environmental layouts. This Kit assists in the development of cognitive mapping skills by helping students organize their physical environment. Has a wide variety of components that can be easily customized or extended, Tactile Town is an ideal starter kit for instruction and reinforcement of mapping skills and concepts.

Recommended ages: 5 years and up.

1-03135-00 \$479.00



## Nearby Explorer Online

The online version of Nearby Explorer is available to download for free on the Google Play store. It contains no onboard map data, so there are no licensing fees to pay, therefore, it is free to you! While Nearby Explorer Online is potentially very useful as a tool everywhere, the online version does require a device with a network connection to use.

**Note:** Nearby Explorer Online is a “lite” version of the Purchased App. It does not give directions, offer a map view, offer compass mode, or explore nearby intersections.

For complete details about Nearby Explorer Online, visit: [tech.aph.org/neo\\_info.htm](http://tech.aph.org/neo_info.htm) To install, visit: <https://play.google.com/store/apps/details?id=org.aph.nearbyonline>

FREE





## Nearby Explorer™ App

This powerful location exploration app is for use online and on Android™ and iOS devices. It's a full featured GPS app that empowers users to independently explore with confidence!

Nearby Explorer uses GPS and your phone's compass to speak real-time information about your surroundings. Includes millions of points of interest (POI) in the U.S. and Canada. When used with a built-in compass, the app also provides feedback about features in your environment. Available in three versions. Individuals are welcome to purchase Nearby Explorer!

An additional feature is Indoor Explorer, which provides location and orientation inside buildings that have been mapped and equipped with beacons.

**Note:** This app cannot be purchased directly from APH, please refer to page 181 on how to order.

**Warning:** Nearby Explorer should be used along with a human guide, dog guide, and/or cane because it does not provide sufficient information to act as a substitute for your preferred O&M method.

### Non-Quota

Search on The App Store or Google Play Store to download.  
\$79.99

### Quota

For Android devices   
**D-20000-AN** \$79.99

For iOS devices  
**D-30022-APL** \$79.99



## Miniguide US

Uses ultrasound to detect objects, and gives tactual or auditory feedback by vibrating or chirping more rapidly as you approach an object. Ideal for use by deafblind persons.

When used with a cane or dog guide, the Miniguide US can help find paths through crowds at ranges from 20 inches to 26 feet.

**Warning:** The Miniguide US should be used along with a human guide, dog guide, and/or cane because it does not detect drop-offs and does not provide sufficient information to ensure safety.

**With Print User's Guide**  
**1-07006-00** \$545.00

**With Braille User's Guide**  
**1-07007-00** \$545.00

## O&M Trivia **N**

Available as an Amazon Alexa Skill or Google Action, O&M Trivia covers a variety of topics including cardinal directions, cane techniques and landmarks. The virtual assistant makes this content accessible in the home, classroom, or on the go!

**Alexa Skill**  
D-03480-AS FREE

**Google Action**  
D-03480-GA FREE

## O&M Tactile Graphics

Helps teach orientation and mobility concepts (compass directions, clock locations, and navigating outside and inside).

Teacher's Guide gives basic ideas for lesson planning using the graphics, suggested concepts, and instructional hints.

Recommended ages: 8 years and up.

1-20100-00 \$46.00

## O&M Family Booklet Software

O&M Family Booklet software from APH is designed for O&M professionals. Let the software do the work for you – just type or select what you want the family to understand.

**CD-ROM**  
D-03480-00 \$50.00

**Digital Download**  
D-03480-ED \$50.00

## Denver The Guide Dog Video

Produced by the Discovery Channel cable network for their Animal Planet® Pet series, this video is for anyone who'd like to know more about guide dogs or would just like to meet Denver.

Celebrate with Heathcliff as he's honored after twelve faithful years of service, and meet the new kid on the block – Denver. In this episode see how Denver got his start, "made the cut" at guide dog school, and was matched with Gary. Be amazed as you watch how hard the two of them have worked to become the team they are.

1-30010-DVD \$15.00

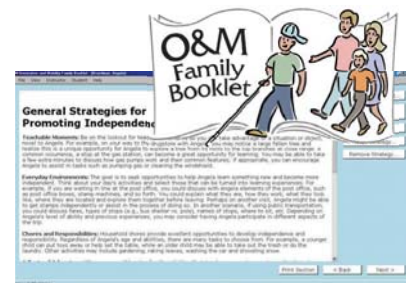
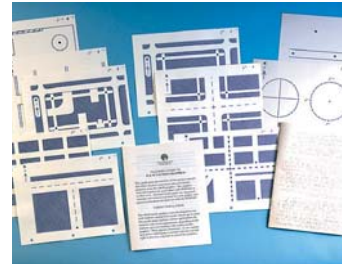



## Step-By-Step: An Interactive Guide to Mobility Techniques ⚠️

Developed by Dr. Sandra Rosen, Step-by-Step guides the user in strategies to identify and correct mobility errors commonly made by new learners. Designed for in-depth study, each spiral bound volume describes in words and pictures how to perform mobility techniques for a given learning module; provides strategies for choosing teaching environments; lists prerequisite and related skills; and includes instructional strategies.

**Warning:** Only O&M specialists should teach the 30 techniques included in Long Cane Techniques, Street Crossing Techniques, Special Environments, and Transportation Techniques modules; however, teachers of students with visual impairments, vision rehabilitation therapists, and other professionals, family members, and friends may wish to learn, as appropriate, some of the 23 techniques included in Human Guide Techniques, Non-Cane Techniques, and Special Techniques modules.

8-75980-00 \$299.00



Orientation & Mobility  
for Wheelchair Users  
with Visual Impairment or Blindness



Video Clip: Backing onto a van lift in a manual wheelchair



One of over 190 video clips: Boarding a train when using a scooter

## Orientation & Mobility for Wheelchair Users With Visual Impairment or Blindness

This web-based publication helps O&M instructors learn how to train students who are wheelchair users to travel safely and effectively. It shares techniques and strategies that are proven successful with clients/students in the rehabilitation setting. Needs an internet connection, works on Windows and Mac operating systems, and iOS devices.

**Note:** This online publication cannot be ordered directly using the APH Shopping Site. Please contact the APH Customer Service Department. This publication IS available with Quota funds.

D-03490-ED \$4.99

## Picture Maker

These picture-making kits can be used for numerous educational and recreational activities! Use optional products for more possibilities.

### Wheatley Tactile Diagramming Kit

This fun, colorful tactile board includes a felt covered board measuring 20 3/4 x 13 inches, and a wide variety of hook-and-loop material-backed pieces that attach to the board in an infinite number of patterns. Features over 100 pieces in many shapes, sizes, textures, and colors. Extra hook-and-loop material provided for helping to create additional tactile pieces. The large print/braille guidebook has suggestions and example layouts.

**1-08838-00** \$159.00



### Textured Strips

Provides additional textured diagramming strips for use with Picture Maker. Strips are different in texture, number, color, and size from those included in the original kit. These strips can be used to represent different map features.

**1-08838-02** \$83.00



Picture Maker felt board NOT included with Textured Strips.

### Storage Panel

Store unused Picture Maker pieces so the entire main Picture Maker board can be used for diagramming purposes. The 8 1/2 x 11 inch panel is double-sided with soft black Veltex® material, 3-hole punched edge, and customer-applied hook-and-loop material tabs.

**1-08838-03** \$20.00

Storage Panel

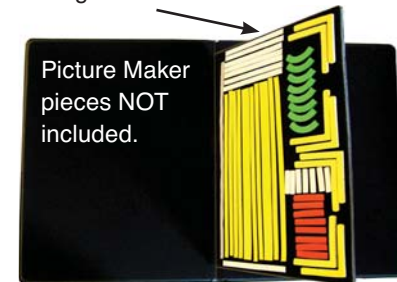

### Geometric Textured Shapes

Provides additional hook-and-loop material-backed textured shapes for use with APH's Picture Maker. Use in combination with the diagramming strips and shapes included in the original kit. Can also be used with APH's All-In-One Boards (Magnetic/Hook-and-Loop Material/Dry Erase).

**1-08838-01** \$69.00



Some parts you receive may vary slightly from those depicted in photos. Felt board is NOT included.

# Assistive Technology and Electronics Section Index



Book Port DT .....	146	Color Star .....	154
Book Wizard Software .....	147	Colorino Talking Color Identifier.....	156
Braille Badges .....	147	Draw2Measure Protractor (for iOS devices) ..	50
BrailleBlaster .....	144	Flip-Over FACES App .....	200
Digital Talking Book Cartridge .....	145	IntelliTactiles Pre-Braille Concepts .....	98
Headphones .....	147	Learn Keys: Verbal Keyboard Feedback.....	101
JAWS and ZoomText.....	145	Miniguide US .....	138
Jupiter Portable Magnifier <b>N</b> .....	144	Money Talks Software .....	157
Math Flash <b>N</b> .....	143	Nearby Explorer.....	137-138
MATT Connect.....	143	Portable Sound Source .....	81
Orbit Reader 20.....	146	Practice2Master Fractions.....	49
Snap Circuits Jr. Access .....	143	Slapstack Math .....	51
USB Charger, 2 AMP.....	147	SMART Brailer .....	113
Visual Brailer.....	146	Studio Recorder Software .....	170
<b>Assistive Technology and Electronics</b>		Sunu Band.....	152
<b>Related Products</b>		Talking GlowDice.....	161
APH Sound Balls.....	80	Talking Products (various).....	156-157
Braille Trail Reader LE.....	5	Talking Typewriter .....	100
Code Jumper.....	7	Video Mag HD .....	126



## Math Flash™

### Now With Alexa Skill!

Based on the popular Math Flash software that combines math flash cards with fun audio feedback and a snarky personality. When triggered, Math Flash will allow students to practice math facts on compatible devices. You may choose from three difficulty levels and select which math operations you would like to focus on (addition, subtraction, multiplication, or division).

Recommended ages: All.

**Alexa Skill**  
**D-19910-AS**  
 FREE

**Google Home Assistant**  
**D-30028-AP**  
 FREE



## Snap Circuits® Jr.

An entry-level product for learning about circuits, current, resistance, switches, motors, and other basic electronics concepts. Sold in stores, it is widely used in classrooms because the parts are durable, colorful, and easy to assemble into projects that light up, make sounds, and more. The Snap Circuits Jr. Access Kit, which is sold exclusively through APH, includes the commercial product and makes it accessible to blind and visually impaired users by providing parts labeled in braille, along with written project instructions in braille and large print.

Developed by APH with generous cooperation and contributions from Elenco®, makers of a wide variety of learning kits. Please visit [www.elenco.com](http://www.elenco.com) for information about their products and services.

Recommended ages: 8 years and up.

**Access Kit**  
**1-03041-00** \$129.00

**Access Pack**  
 (labels and instructions only)  
**1-03042-00** \$73.00



## MATT Connect™

The MATT Connect is a magnifier, distance viewer, and an educational tablet with pre-loaded software – all in one device!

Students can magnify a print document or read a book from an online library and have the ability to conduct internet research, view a distant or connected smartboard, while writing and emailing assignments. The 12-inch HD touchscreen is lightweight, sturdy, and extremely portable with removable stand.

The MATT Connect is available with Quota funds.

**1-03941-00** \$2,995.00 + shipping



800.223.1839



## Jupiter Portable Magnifier **N**

American Printing House  
**INNOVATIONS**

Whether it's in the classroom, workplace, or at home - this powerful HD magnifier allows you to continue those activities that bring joy to everyday life, while exploring new opportunities for lifelong education.

### Features

- LCD Screen Size: 13"
- Weight: Approx. 8 lbs.
- Three camera modes:
  - Reading: excellent for reading a book, prescription bottle labels, completing a homework assignment, etc.
  - Distance-view: magnifies up to 150x and is great for viewing a presentation, guest speaker, instructor, etc., at the front of a classroom/venue.
  - Self-view: serves just like an HD mirror, and is perfect for applying make-up and other grooming activities.
- LED screen with adjustable light brightness.
- 35 color contrasting color modes to select according to your viewing preference and comfort.
- Jupiter's durable and portable design allows you to take this easy-to-use magnifier on the go!

### Includes

- Jupiter Portable Magnifier unit
- Power adapter
- Carrying pouch
- Large print user manual

Not available with Quota funds.

**1-00370-00** \$3,200.00

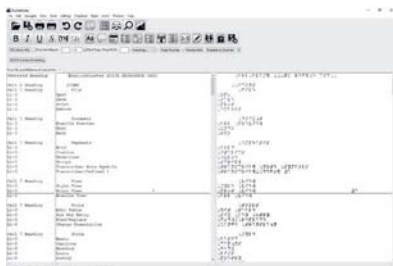
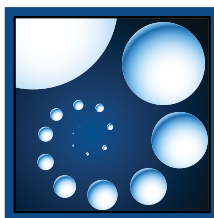

## BrailleBlaster™

BrailleBlaster software is a revolutionary new tool for braille transcribers and others who need to produce high-quality braille material. It takes advantage of the rich markup contained in NIMAS (National Instructional Materials Accessibility Standard) and EPUB files to automate basic translation and formatting, and to make advanced tasks quicker and easier. Designed primarily for editing braille textbooks that meet the specifications published by BANA, the purpose of BrailleBlaster is to help braille producers ensure that students have the necessary textbooks on the first day of class.

Download from: [www.brailleblaster.org](http://www.brailleblaster.org)

FREE

## JAWS and ZoomText

We don't open doors for people. We create the tools for people to open their own.

APH and Freedom Scientific have partnered to make the world's most popular screen reader (JAWS®) and screen magnifier (ZoomText®) software available to APH customers at lower prices!

### JAWS (Job Access With Speech)

Students who are blind and visually impaired can easily navigate, read and write documents, and create presentations from their school PC or from home. JAWS provides speech and braille output for the most popular computer applications.

**D-11002-ED Annual Subscription \$90.00**

### ZoomText

Students with low vision can enlarge and enhance everything on their computer screen. ZoomText also echoes your typing and essential program activity, and automatically reads documents, web pages, and email.

Using the new **Software License Portal**, teachers and administrators can manage their licenses and move them between computers. Licenses are registered directly to an email address. Software can be installed on all versions of Windows® 7 or later.

Please visit **aph.org** to order, to learn more, or to find related products.

**D-11003-ED Annual Subscription \$80.00**

## Digital Talking Book Cartridge

This 4GB blank cartridge is for use with the National Library Service (NLS) Digital Talking Book Players. Connect this cartridge to your PC via a USB cable (purchased separately) to download NLS books.

Also available are Digital Cartridge Mailers that hold one cartridge for storage or mailing. Has a slot for a mailing label.

For more information about NLS digital talking books, <http://www.loc.gov/nls/digital.html>

**1-02609-00 \$13.00**

**JAWS**  
SCREEN READER

**ZoomText**  
MAGNIFIER WITH SPEECH





## Book Port DT™

Loaded with many of the same features as our hand-held Book Port Plus, the Book Port DT is a desktop-style Digital Talking Book player and recorder. Ideal for reading Digital Talking Books. Record or edit your own material in Digital Talking Book format. Enjoy listening to internet radio or downloading podcasts for education or entertainment.

**Note:** The unit must be authorized through Learning Ally or NLS to play recordings from these organizations. You also need to have an account to use **bookshare.org** You can also download books from the NLS BARD website, **nlsbard.loc.gov**

1-07200-00 \$423.00 + shipping



## Orbit Reader 20™

The Orbit Reader 20 unit combines simplicity, functionality, and connectivity in a refreshable braille display priced at a fraction of the cost of similar devices! Made possible by the Transforming Braille Group, LLC (TBG), a consortium of world-wide blindness organizations.

Though feature-rich, the Orbit Reader 20 is simple to use and allows switching between the different functions seamlessly. Its Stand-Alone capabilities include reading, writing, and file management. Orbit Reader 20 starts as a reader displaying the content of files stored on the SD™ card. For more advanced users, Orbit Reader 20 provides searching, bookmarking, and note taking capabilities.

Carrying case available from Orbit Research:

[www.orbitresearch.com/or20](http://www.orbitresearch.com/or20)

1-07419-00 \$699.00 + shipping



## Visual Brailer (for iPad)

Visual Brailer™ is a braillewriter app for your iPad®. It displays a traditional six-dot keyboard and simulated braille on your iPad screen. You can edit and save your work. Visual Brailer supports any code you wish to use, because it makes no assumptions about what you are writing.

Visual Brailer also works with Bluetooth refreshable braille displays with keyboards.

Search on The App Store or Google Play Store to download.

FREE



## Book Wizard Reader and Producer Software

Book Wizard Reader™ lets you read a wide variety of types of digital talking books.

Book Wizard Producer™ has all the features of Reader, but adds the ability to create digital talking books on your PC. The program adheres to the DAISY/NISO 2002 definitions and provides users with enhanced ability to control and navigate through both structured and unstructured audio files. Producer is compatible with source input of either a narrator who reads directly into the program or an imported audio file created from another source.



### Book Wizard Reader

#### CD-ROM

D-03531-00 \$49.00

#### Digital Download

D-03531-ED \$39.00

### Book Wizard Producer

#### CD-ROM

D-03530-00 \$200.00

#### Digital Download

D-03530-ED \$200.00

## Headphones

Compatible with APH technology products. A stereo to mono adapter plug is required to use these headphones with older monaural players. Both have 3.5mm plugs.

### Private Phones

1-07088-00 \$21.00

### Stereo Headphones

1-18986-01 \$14.50



Both include volume control.

## Braille Badges

APH Braille Badges are for iMessage®! This fun, accessible sticker pack is great for sharing.

Available from the App Store: [itunes.apple.com/us/app/braille-badges/id1173603989?ls=1&mt=8](https://itunes.apple.com/us/app/braille-badges/id1173603989?ls=1&mt=8)

FREE



## USB Charger, 2 Amp

This handy USB wall charger may be used to charge several APH products. Power output is 2 amps. Accepts a Standard A USB plug. This unit also charges many commercial devices that recharge via USB cable.

1-03966-00 \$32.00



# Career Education and Transition Section Index

ECC Icon Poster .....	148	Money Handling and Budgeting .....	157
Transition Tote System .....	149	Money Talks Software .....	157
Quick & Easy ECC Hatlen Center Guide.....	149	PATTER.....	25
<b>APH Products Related to Career Education and Transition</b>			
Going Places: Transition Guidelines .....	81	Reach for the Stars, Planning for the Future .....	24
JAWS and ZoomText.....	145	Orion TI-84 Plus Talking Graphing Calculator.....	53
		Talking Typewriter .....	100

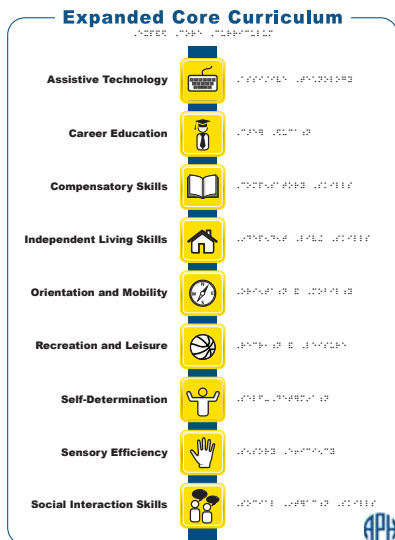

## ECC Icon Poster

The ECC Icon Poster is a wall-sized print/tactile poster that lists the Expanded Core Curriculum skills important for the specialized instruction of students who are blind and visually impaired. Each skill area is represented with a tactile/print icon and print/braille description.

The poster is complemented by a separate 2-page large print flyer (with a separate braille version) that provides a very detailed description of each ECC skill area. The content of this flyer was reprinted, with minor modifications, with permission from the Texas School for the Blind and Visually Impaired.

The ECC Icon Poster measures 18 1/2 x 22 1/2 inches and has a die-cut hole for convenient hanging in a classroom setting.

**1-08205-00 \$64.00**

## Quick & Easy Expanded Core Curriculum: The Hatlen Center Guide

Designed for transition students who are visually impaired. The lessons, categorized by setting (home/school or community), are intentionally designed to be completed in 5–15 minutes. They are not designed to replace a comprehensive program addressing the ECC.

**Note:** The entire binder contents are only available as a braille ready format (.brf) file.

1-08204-00 \$48.00

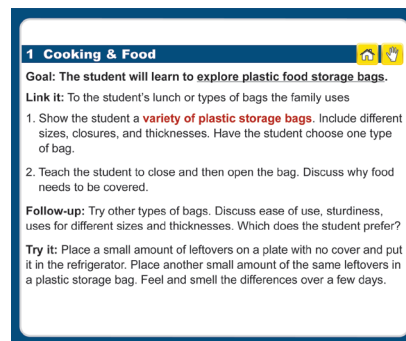

ECC lesson card

## Transition Tote System “Navigating the Rapids of Life”

Transition Tote materials teach middle school, secondary, and transition students with visual impairments essential skills for learning about themselves and the world of work. In addition to seven new lessons and the custom designed backpack, this kit includes updated descriptions of technology, revised resource and reference materials, and an updated Facilitator’s Guide.

1-08210-00 \$277.00

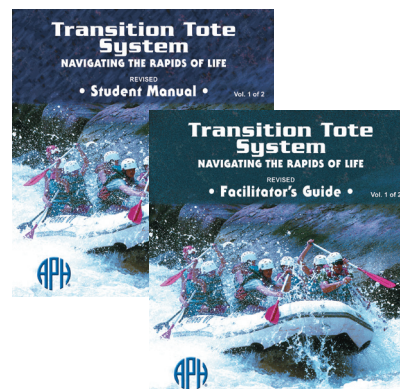

## Transition Tote System Backpack

This attractive, sturdy backpack is a perfect solution for organizing and transporting equipment and tools used by students and professionals. Designed to serve the changing needs of persons with visual impairments as they proceed through school, transition and vision rehabilitation programs, and into the adult world.

### Features

- Key ring attached by hook-and-loop fastener
- 3 pen/marker/stylus holders
- Slate/magnifier pocket
- Zippered change pocket
- Cell phone/PDA pocket with hook-and-loop closure
- Back padded compartment with adjustable hook and loop strap protects a laptop or similar device
- Back panel with pockets for storing media
- Front panel with 3 padded pockets electronic items

1-08211-00 \$72.00



# Self-Determination Section Index



Getting to Know You .....	150	Quick & Easy ECC .....	149
<b>Self-Determination Related Products</b>		Reach for the Stars .....	24
Going Places .....	81	Reclaiming Independence .....	155
Loving Me .....	169	Sensory Learning Kit .....	34
PATTER .....	25	Teen Scene: Portraits of Success Video .....	125
		Transition Tote System .....	149

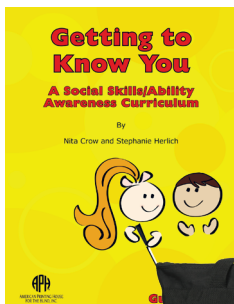

Kit also includes the APH Innovations Tote Bag



## Getting To Know You: A Social Skills/ Ability Awareness Curriculum **PARTS**

The Getting to Know You curriculum is divided into three groups: kindergarten through second grade, third through fifth grade, and middle/high school, and is designed for Vi teachers, O&M specialists, other related service personnel, general education teachers, and families. Lessons take 30–45 minutes to complete. Each lesson contains a clearly stated objective, skills addressed, an introduction, a list of materials needed, and a step-by-step explanation of the activities.

**1-08052-00 \$299.00**



# Daily Living and Social Interaction Section Index



APH Signature Guide .....	159	Tactile Clothing Tape .....	156
Braille DateBook <b>R</b> .....	155	Talking Cooking Thermometer.....	157
Color Star .....	154	Zeitgeist.....	156
Colorino Talking Color Identifier.....	156		
Deafblind Pocket Communicator.....	154	<b>Daily Living and Social Interaction</b>	
EZ		<b>Related Products</b>	
Fill Pouring Aid .....	157	Brailleable Labels and Sheet.....	87
Test Battery Tester .....	156	Braille Badges .....	147
Track Products .....	158	Braille Folders, Binders, Notebooks .....	114, 119–120
Functional Skills Assessment <b>N</b> .....	153	Feel 'n Peel Stickers .....	94–95
Keitzer Check Writing Guide .....	154	Getting to Know You .....	150
Labeling, Marking, and Organization.....	159	MiniGuide US .....	138
MagneTachers Magnetic Labels .....	159	Plastic Binder Envelopes for Braille.....	120
MiniBook Braille Quick-Note Products.....	155	PermaBraille .....	116
Money Handling and Budgeting .....	157	ReadWrite Stands .....	102
Money Talks Software .....	157	Transition Tote Backpack.....	149
Reclaiming Independence Video.....	155	Video Mag HD .....	126
Push Button Padlock .....	159		
Sunu Band <b>N</b> .....	152		

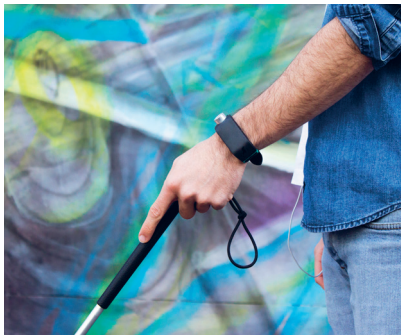

**Sunu Band®**  

The Sunu Band is a modern and sleek, smart mobility wristband that uses ultrasonic technology to detect and alert you to navigational obstacles up to 14 ft. away.

**Features**

- Used as a supplement to the white cane, you'll enjoy improved spatial awareness and the personal freedom of knowing where you are and what's around you.
- Powerful navigation sensors and haptic feedback inform how near, or far, navigational obstacles are to the user, thus reducing accidents to the body, chest, arms, and head.
- Easy interface with touch panel and gesture recognition control.

**Includes FREE download of the Sunu App**

- available for iPhone® or Android™ devices
- fully customizable, including Band sensitivity and distance reading capabilities
- access to new apps and firmware updates over the cloud

Conveniently tell time, set discreet vibratory alarms, and track physical activity and other fitness metrics.

Explore unfamiliar places with Sunu Band's haptic compass, place finder/ explorer and GPS navigation.

Sunu Band's sleek design features an adjustable, black sports wristband with teal accents.

**Includes**

- Sunu Band (battery included, not removable)
- USB to micro USB cable
- Quick Start Guide

 **Warning:** The Sunu Band is not a regulated safety device, and should not be used as a replacement of existing visual aid systems.

Sunu Band and other APH Innovations products are not available for purchase with quota funds.

**1-03140-00 \$299.00**



# Functional Skills Assessment

The Functional Skills Assessment (FSA) is a tool used to evaluate daily living skills for students at all levels. Broken into modules, FSA covers a number of skills within four facets of independent living: Clothing, Food, Home, and Self Management. Online scoring pages are available at <https://funcsk.aphtech.org>. Users can unlock the forms using a code published inside the manuals.

Student Assignment files are provided online in both .brf and .docx formats. Assessment Manuals are also provided online as .brf files.

Recommended grades: Grades K–12.

## Clothing

The Clothing Management module of FSA covers clothing storage, laundering, sewing, and more.

**Print Manual**  
7-08232-01 \$59.00

**Print Scoring Book**  
7-08233-00 \$88.00

**Braille Manual**  
5-08232-01 FREE Download

## Food

The Food Management Assessment module of FSA covers cooking tools and utensils, menu planning, food preparation, and more.

**Print Manual**  
7-08232-02 \$87.00

**Print Scoring Book**  
7-08234-00 \$96.00

**Braille Manual**  
5-08232-02 FREE Download

## Home

The Home Management Assessment module of FSA covers organizing surfaces and materials, household chores, home safety practices, and more.

**Print Manual**  
7-08232-03 \$48.00

**Print Scoring Book**  
7-08235-00 \$67.00

**Braille Manual**  
5-08232-03 FREE Download

## Self

The Self Management Assessment module of FSA covers grooming, social skills, consumer skills, and more.

**Print Manual**  
7-08232-04 \$57.00

**Print Scoring Book**  
7-08236-00 \$75.00

**Braille Manual**  
5-08232-04 FREE Download

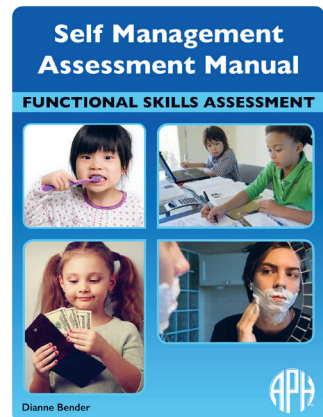
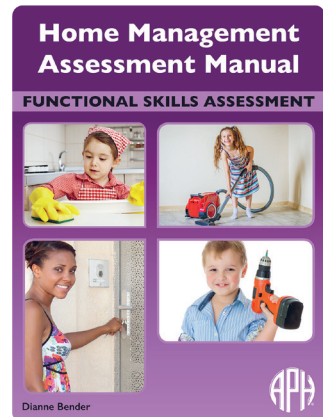
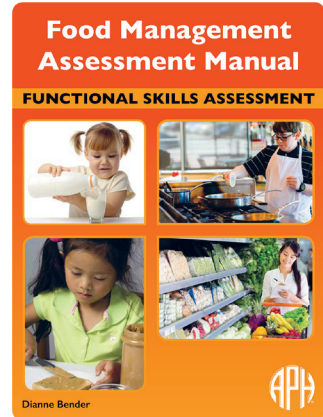
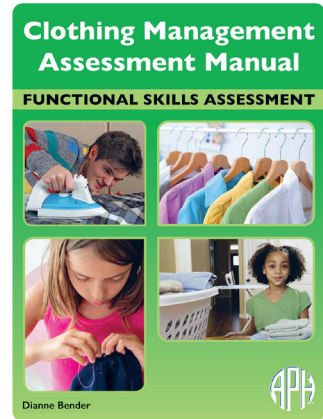



## Color Star

Color Star® is a powerful color identifier. It recognizes more than 1,000 different color shades, identifies contrast measurements, recognizes the color of LED lights, perceives the light intensity in the surrounding environment, and recognizes patterns – all with clear spoken voice output.

**1-03952-00 \$449.00**



## Keitzer Check Writing Guide

A flexible, durable, polyethylene guide that will hold any standard check. A slant is located at the upper left corner for orientation. This guide allows you to feel the locations of the various blanks on a standard sized check and write in the correct areas.

The closed guide measures 3 1/2 x 6 1/4 inches and easily fits in a shirt pocket or purse. It works with checks that are standard size and have a standard layout.

**1-03528-00 \$10.00**

**1-03528-VET** Call about our special offer for veterans.

Letter side



## DeafBlind Pocket Communicator

Durable, washable, and easily fits in your pocket or bag. The smooth numbers side and the matte letters side lets you know “at first touch” which side you need to chat with someone.

The breakaway lanyard option gives you some freedom to carry other items and to access the Deafblind Pocket Communicator (DBPC) with ease.

Communication cards can be helpful when using the DBPC with people at a coffee shop or in a store. Sample messages might include: “How much does this cost?” or “Use my finger to show me the answers on this device.” Feel free to design your own communication cards to meet your unique needs.

**1-16999-00 \$57.00**



Number side

## Minibook Braille Quick-Note Products

Two formats help you jot down small bits of information quickly!

- MiniBook Slate with Styluses: This tiny slate has four lines, 15 cells per line. The cells have side indentations, making it easy to find the dot you want to make. It comes with three styluses: saddle, tall flat, and short flat. Choose the one that fits your hand most comfortably.
- Mini Spiral Notebook (2-pk): The Mini Spiral Notebook includes 50 pages perforated for easy removal. Fasten the slate to the first blank page, then when you pull the notebook out of your pocket, you're ready to write!



**Minibook Slate  
With Styluses**  
1-07850-00 \$12.00

**Mini Spiral Notebook**  
1-07853-00 \$9.00

## Braille Datebook **R PARTS**

An attractive planner-organizer designed specifically for braille users! Binder with pockets, 250 sheets of paper, tabbed calendar pages, blank tabs, and stylus.

Recommended ages: 11 years and up.



**Datebook**  
1-07899-20 \$89.00

**Calendar Pages Only**  
1-07898-20 \$13.00

## Reclaiming Independence: Staying in The Driver's Seat When You no Longer Drive Video

Useful for both individuals and professionals, this video/ resource guide will help you successfully use rehabilitation and transportation resources. Real people share their stories as they make the transition from driver to non-driver. Includes a narrated version of the Resource Guide. Included Resource Guide is in large print and on CD-ROM. Closed captioned.

1-30020-DVD \$30.00

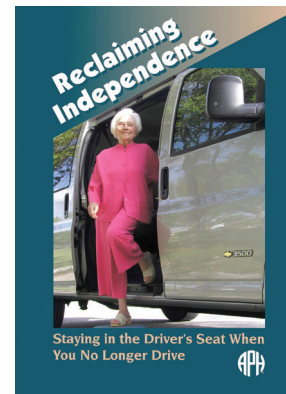



## Colorino Talking Color Identifier

This simple talking color identifier is a small, hand-held unit that is easy to operate using only two buttons. The Colorino can detect more than 100 nuances of color and be used as a light detector. Uses 2 AAA batteries (included) and comes with a carrying case; cassette, large print, and braille “quick start” instructions; and a one-year warranty.

**1-03955-00 \$227.00**



## Zeitgeist Talking Time Machine

This hand-held device combines a number of time-related functions and speaks through its speaker or headphones (not included). Fits in pocket or carry around neck on attached lanyard, uses 2 AAA batteries (included). A Spanish edition is also available.

Available with Quota funds.

**English**  
**1-03974-00 \$106.00**

**Spanish**  
**1-03974-SP \$106.00**



## Tactile Clothing Tape

Allows braille readers to keep colors and other information about their clothing and linens exactly where they need it: attached to the item and ready to be read. The brailled information remains clean and readable after going through automatic washers and dryers, and even holds up under an iron as long as a layer of fabric is kept between the iron and the label!

**Warning:** This product contains safety pins. DO NOT use with children under 12 years unless directly supervised.

**1-07420-00 \$59.00**

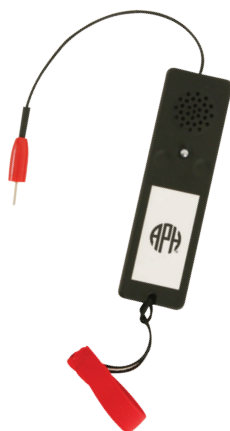

## EZ Test Battery Tester

APH offers two versions of the EZ Test Battery Tester:

- The Audible EZ Test reports battery status by beeps
- The Audible/Tactile EZ Test reports battery status by vibrations and beeps

A flexible testing wire allows for testing of 1.5 volt batteries, including AAA, AA, C, and D batteries. Also included are two contacts for testing 9 volt batteries.

**Audio Feedback**  
**1-03968-00 \$62.00**

**Audio/Tactile Feedback**  
**1-03969-00 \$78.00**



## Talking Cooking Thermometer

Use this large-display talking thermometer for cooking, hobbies, gardening, and much more! It's a must have item to make everyday living easier! Use the built-in eyelet at the top to hang the thermometer within easy reach.

**Note:** This thermometer is not for medical use.

**1-03992-00** \$39.00



Large 3/8-inch digits, great for low vision users!

## Money Handling and Budgeting

Resource guide with an adapted practice checkbook that helps students learn vital money handling skills.

Recommended ages: 11 years and up.

**Print**

**1-83080-00** \$57.00

**Braille**

**1-83081-00** \$63.00



## Money Talks™ Software

Accessible and flexible bank account management software that provides printing and braille embossing of the check register, and writing checks in a variety of sizes and styles. Requires a PC running Windows® 7 or later.

**CD-ROM**

**D-03560-00** \$49.00

**Digital Download**

**D-03560-ED** \$39.00



## EZ Fill Pouring Aid

This device aids in filling containers. The aid hangs on the edge of the container, and when liquid fills to about one inch from the top, the device produces a signal, alerting the user. Uses three included LR44 button-type batteries, with an expected life span of about one year.

**1-03970-00** \$20.00



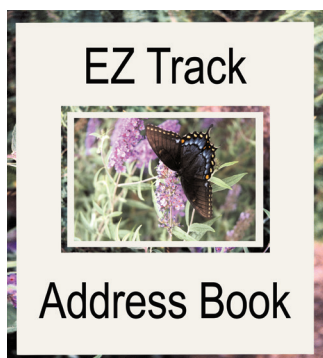
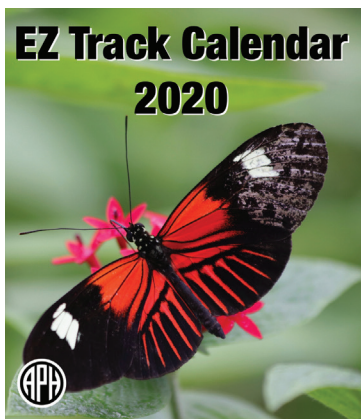

## EZ Track Products

EZ Track is a multi-faceted line of low vision products to help you get organized...and stay that way!

Designed for people with low vision, EZ Track products utilize large print of at least 18 points, easy-to-use binder formatting, and special accessories as aids in organizing important day-to-day activities.

### Calendar: A Low Vision Appointment Book and Calendar **R**

Designed for people with low vision, EZ Track products utilize large print of at least 18 points, easy-to-use binder formatting, and special accessories as aids in organizing important day-to-day activities.

**With Binder**  
1-07900-20 \$TBA

**Inserts Only, No Binder**  
1-07901-20 \$TBA

### Address Book **PARTS**

Large print address book holds 208 addresses. Includes a plastic template for easy entry. Large alphabet tabs make names easy to find in the 3-ring binder.

1-07910-00 \$69.00

### Medical Record Keeper

Large print organizational tool for keeping medical records. Provides a system for storing and organizing information on personal identification, medical history, insurance, medications, physicians, and other medical records. Printed non-glare paper, with 22-point black type.

Includes a 3-ring binder, folders, and tab pages.

1-07930-00 \$109.00

### Financial Record Keeper **PARTS**

Large print system for keeping track of information about banking, utilities, income, taxes, insurance, mortgages, investments, retirement plans, and much more!

Information is stored in tabbed sections. Stored in a 3-ring binder and includes large print Check Register, storage pouch, three storage folders, and a user's guide.

1-07920-00 \$125.00



## APH Signature Guide

This small, pocket-sized frame has an opening with an elastic band. The band provides a guide for writing and flexes to allow for the descenders of letters. Guide is made of aluminum with a rubber backing to prevent sliding.

Recommended ages: 8 years and up.

1-03530-01 \$10.00



## Push Button Padlock

Each lock comes with two large print/braille cards listing the combination, along with large print and braille instructions. Buttons eliminate the worry of losing a key.

1-03990-01 \$22.00

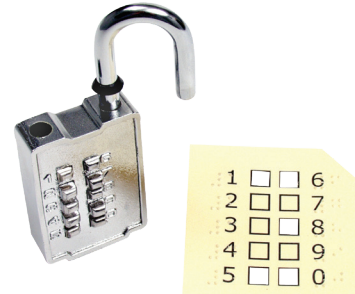

## MagneTachers Magnetic Labels

MagneTachers are magnetic labels that attach to metal objects, are easily removable, and re-attachable! You can create labels in large print and braille. Instructions in print and braille included.

### Large Print Labels

(2 Rolls, 1 inch high)

1-07418-00 \$7.50

### Braille/Large Print

Labels (2 Rolls, 0.5 inch high)

1-07416-01 \$14.00



## Labeling, Marking, and Organization: A Self-Help Guide for Persons After Vision Loss

If you are tired of opening apricots instead of tomatoes, wearing your navy shirt with black slacks, or floundering through files when trying to find your utility bill, then Labeling, Marking, and Organization may be the book you need! It contains practice activities that help you develop new ways to identify items with labels you can no longer read.

Recommended ages: 14 years and up.

### Large Print With CDs

7-08870-00 \$69.00

### Braille (3 Vol.) With CDs

5-08870-00 \$95.00



# Recreation and Leisure Section Index

## C R O S S W O R D

Crossword <b>N</b> .....	162	Flip-Over FACES App .....	200
Game Kit .....	162	Games for People with Sensory Impairments.....	80
Games of Squares.....	164	Gross Motor Development Curriculum .....	81
Scattered Crowns: Tactile Attribute Game.....	161	Joy Player, The .....	34
Score Card Set .....	161	Jump Rope to Fitness Kit .....	82
Slide, Twist 'N Solve .....	163	Magazine Subscriptions .....	175
SQUID Tactile Activities Magazine .....	164	Paint Pot Palette .....	77
Talking GlowDice.....	161	Picture Maker .....	141
Talking Word Puzzles Software.....	163	Portable Sound Source .....	81
Touch 'em All Baseball.....	161	Quick-Draw Paper .....	98
TREKS Game .....	163	Reach & Match .....	21
Web Chase Board Game .....	162	Rib-It-Balls.....	80
Wooden Junior Constructo Set .....	164	Six Dots Game of Cards .....	23
Word Quest Puzzles .....	162	Slapstack Math .....	51
 <b>Recreation and Leisure Related Products</b>		Sunu Band.....	152
APH Sound Ball.....	80	Tactile Tangrams .....	50
Armadillo Army Software .....	134	Tangle Toy .....	39
Braille Badges .....	147	30-Love Tennis Kit.....	82
Braille Beads .....	77	Termite Torpedo Software .....	134
Bright Line Reading Guide .....	126	Toodle Tiles Software .....	134
Color-by-Texture Marking Mats .....	77	Time for Art .....	76
		Walk/Run for Fitness Kit .....	82

## Touch 'Em All Baseball

Touch 'em All Baseball is easy to learn. You'll need to be familiar with the basic rules of baseball, but you don't need a lot of expertise to enjoy this game.

The Teacher's Kit (sold separately) provides suggestions for using Touch 'em All Baseball with students, not only to teach about baseball but to develop other skills. This kit includes a set of tactile/print "stick figure" diagrams, and suggested physical activities that correspond to the images.

Recommended ages: 8 years and up.

<b>Game</b>	<b>Teacher's Kit</b>
1-08101-00 \$244.00	7-08101-00 \$31.00



## Score Card Set

Generic Score Card made of durable plastic. Has twenty buttons in two rows of ten. Push down on a button to register one event. Pop up buttons to clear. Includes one yellow and one green card. Instructions in print and braille.

Recommended ages: All.

1-17001-00 \$28.00

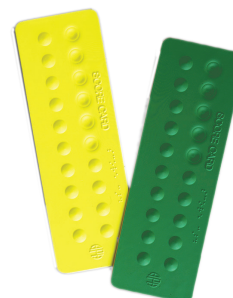

## Talking GlowDice

Push the Roll button and a randomly generated number between one and six is announced in digital speech, and the corresponding number is displayed in bright blue LEDs.

Takes 4 AAA batteries (not included).

1-07500-00 \$33.00



## Scattered Crowns: Tactile Attribute Game

A fun, versatile board game that encourages young children, especially those with visual impairments and blindness, to develop tactile skills. As players search for crowns with specific attributes they will practice texture/shape/size discrimination, tactile memory, systematic searching skills, and spatial concepts. Other concepts include counting, turn-taking, sorting/organizing, and social interaction skills.

Recommended ages: 5 years and up.

1-08462-00 \$281.00





## Game Kit

A collection of common game parts designed for use by players who are visually impaired and blind. Parts can be used to play games from the included handbook, to adapt commercial games, or to create new games. Use to build social skills or to review school subjects.

Recommended ages: 5 years and up.

**1-08440-00 \$299.00**



## Web Chase

An originally designed board game by APH that is intended to develop important tactile skills within a fun, recreational context. As players navigate their hungry spiders through an insect-laden web, they learn to trace various raised lines, identify point symbols, and discriminate textures and shapes.

Recommended ages: 5 years and up.

**1-08460-00 \$304.00**

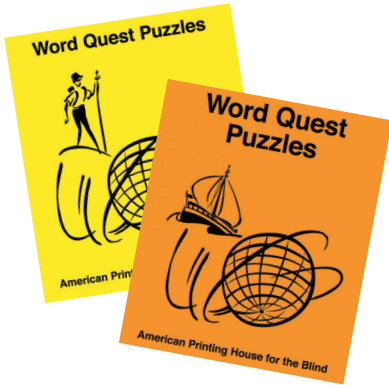

## Word Quest Puzzles

This recreational/educational product presents classic find-the-hidden-words-in-the-grid puzzles in a large print format. Two sizes of letters are available to accommodate different users.

**1/2 Inch Letters**  
**8-05101-00 \$5.00**

**1 Inch Letters**  
**8-05102-00 \$7.00**



## Crossword

Now individuals who are blind or visually impaired can enjoy solving crossword puzzles on their computer!

Crossword is an accessible, cross-platform web app for solving digital crossword puzzles. This free download is compatible with most browsers and screen readers.

Search on The App Store or Google Play Store to download.

**D-19912-OL FREE**



## Talking Word Puzzles® Software

Create or solve hidden word and crossword puzzles in large print. As the player navigates through the puzzle, the program announces the contents of that square.

Find detailed software purchasing instructions on page 181.

Requires Windows® 7 or later.

Recommended ages: All.

### CD-ROM

D-03440-00 \$49.00

### Digital Download

D-03440-ED \$39.00

## Slide, Twist 'N Solve: Tactile Brain Teaser

The attached pieces of this accessible puzzle easily slide and twist. Raised tactile patterns make it easy to identify various patterns; high contrast colors make it ideal for those with low vision. Compare your results to the solution key on the back!

Recommended ages: 6 years and up.

1-03991-00 \$16.00



## TREKS: The Game of Compass Directions

The goal of the game is to be the first player to move your pieces across the board from your home row into the opponent's home row. Change the game to make the play simpler or add rules to make it more complex.

The kit includes a game board, tactually and visually contrasting treksters, rules and variations booklet in large print and braille, and a set of tactile dice.

Recommended ages: 8 years and up.

1-08910-00 \$152.00

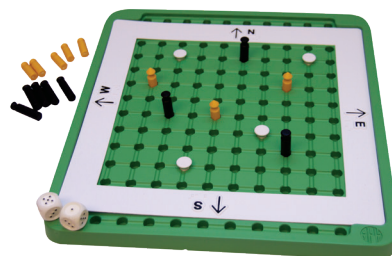



## Games of Squares

The 8x8 inch grid board and accompanying game pieces incorporate color contrast and distinctive textures and shapes that can be easily discriminated by individuals with visual impairments and blindness. Starter ideas and possible adaptations are provided in Beyond X's and O's within the Game Instruction booklet.

Recommended ages: 5 years and up.

1-08430-01 \$278.00



## SQUID Tactile Activities Magazine

SQUID Magazine is deceptively fun: while your student enjoys a variety of activities, he or she will acquire skills needed to become a more proficient tactile reader.

Recommended ages: 5 years and up.

**Note:** Many of the tactile puzzles are reusable and are intended to grow with the child as he or she acquires new skills and tactile understanding.

**Issue 1**  
1-08862-01 \$73.00

**Issue 5**  
1-0886205 \$119.00

**Issue 2**  
1-08862-02 \$81.00

**Issue 6**  
1-08862-06 \$81.00

**Issue 3**  
1-08862-03 \$92.00

**Issue 7**  
1-08862-07 \$95.00

**Issue 4**  
1-08862-04 \$86.00

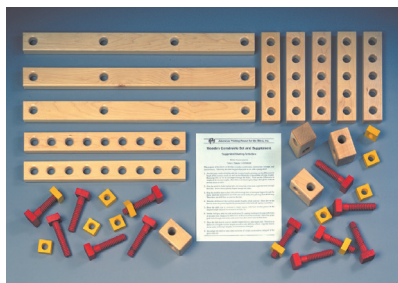

## Wooden Junior Constructo Set

Helps children develop creativity, problem-solving skills, muscular coordination, manual dexterity, and construction concepts. Lengths are linked together with color-coded nuts and bolts.

Recommended ages: 4 years and up.

1-03690-00 \$199.00

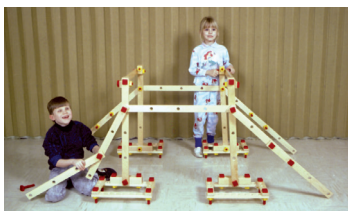

# Video Section Index



APH offers videos for purchase on a wide variety of topics. This is a complete list of videos in this catalog. In addition, visit the APH website to view a growing selection of free-of-charge streaming video product guides.

Child-Guided Strategies for Assessing Children who are Deafblind or Have Multiple Disabilities .....	16
Denver the Guide Dog .....	139
Hands-On Experience with the Cranmer Abacus .....	62

Reclaiming Independence: Staying in the Driver's Seat When You No Longer Drive .....	155
Teach Me to See .....	125
Teen Scene: Portraits of Success .....	125
VIPS Video Library Series .....	40-41

# Resources for Professionals Section Index



Braille Codebooks, BANA .....	167–168	EZ Track Products .....	158
Illinois Braille Series <b>R</b> .....	167	Feel ‘n Peel Reward Stickers .....	94–95
Impressor Braille Business Card Embosser .....	170	Getting to Know You .....	150
Loving Me .....	169	Labeling, Marking, and Organization .....	159
Materials Carry-All .....	170	Nemeth Code Reference Sheet .....	59
Self-Esteem and Adjusting with Blindness .....	169	Nemeth Tutorial .....	51
Studio Recorder Software .....	170	On the Way to Literacy Series .....	26–30
Teaching the Student with a Visual Impairment .....	169	Orion TI-84 Plus Talking Graphing Calculator .....	53
<b>Resources for Professionals</b>		Quick Check .....	101
<b>Related Products</b>		Student Starter Pack .....	93
APH InSights Art Calendar .....	171	Super-Sized Folders .....	120
Book Wizard Software .....	147	Teacher’s Pet Software .....	16
Brailleable Labels and Sheets .....	87	Textured Paper Collection .....	97
Braille DateBook .....	155	Transition Tote Backpack .....	149
ENVISION I & II .....	125	VIPS@Home Parent Empowerment Program .....	33
		Video Mag HD .....	126
		Visual Brailer .....	146



## Illinois Braille Series, Book 1

The Illinois Braille Series (UEB) is a classic program designed to teach braille code to adults transitioning from print to braille literacy. Book I topics and lessons cover the braille alphabet and numbers, and basic punctuation symbols.

**Note:** Content has not changed, but braille formatting has been improved.

<b>Print</b>	<b>Uncontracted Braille</b>
7-17230-01 \$19.00	5-17230-02 \$39.00

**Book 2 Coming Soon!**

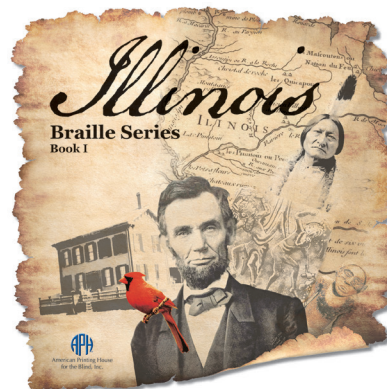

## Braille Codebooks – BANA

The mission of the Braille Authority of North America (BANA) is to assure literacy for tactile readers through the standardization of braille and tactile graphics. It publishes rules for formatting and serves as the authority for braille transcribing.

### Braille Formats: Principles of Print-To-Braille Transcription, 2016

With the implementation of UEB, these guidelines provide a foundation for transcribing print content in an accurate and consistent manner. A wide variety of examples are included. Available for free download on the BANA website:  
[www.brailleauthority.org/formats/formats2016.html](http://www.brailleauthority.org/formats/formats2016.html)

<b>Braille</b>	<b>Print</b>
5-09653-00 \$259.00	7-09653-00 \$259.00

### Music Braille Code, 2015

Where appropriate, rules and procedures have been adjusted to comply with the adoption of The Rules of UEB and of Braille Formats: Principles of Print-to-Braille Transcription. A section about transcribing music for harps has been added. It also incorporates some signs that are not defined in either that work or in the New International Manual of Braille Music Notation. Available for free download on the BANA website:  
[www.brailleauthority.org/music/music.html](http://www.brailleauthority.org/music/music.html)

<b>Braille</b>	<b>Print</b>
5-09651-00 \$189.00	7-09651-00 \$189.00

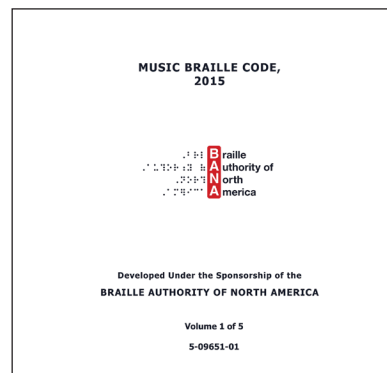
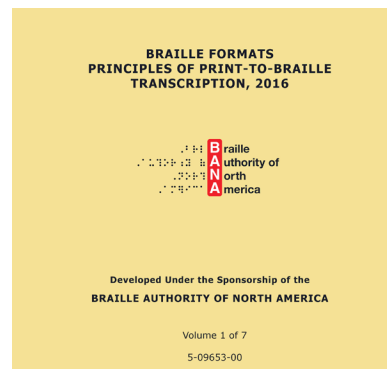

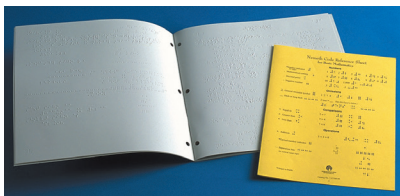

## Nemeth Code for Mathematics and Science Notation, 1972 Revision

Braille  
5-87430-00 \$89.00

Print  
7-87430-00 \$89.00

## Addendum 1 to the Nemeth Code for Mathematics and Science Notation, 1972 Revision: Ancient Numeration Systems

Braille  
5-68654-00 \$15.00

Print  
7-68654-00 \$15.00

## Braille Code for Chemical Notation

Braille  
5-16900-00 \$79.00

## Learning The Nemeth Braille Code: A Manual for Teachers and Students

Braille  
5-68653-00 \$49.00

Print  
7-68653-00 \$49.00

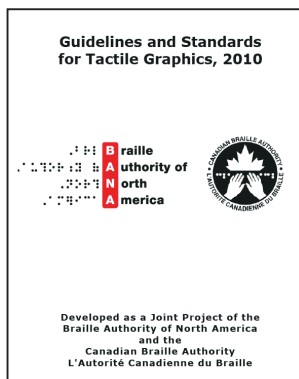

## Guidelines and Standards for Tactile Graphics

Print  
7-35935-00 \$99.00

Braille  
5-35935-00 \$99.00

Supplement, Print  
7-35936-00 \$189.00

Supplement, Braille  
5-35936-00 \$189.00

## Teaching the Student With a Visual Impairment (TSVI): A Primer for the Classroom Teacher

TSVI assists the all-inclusive classroom teacher in preparing for the unique educational needs of the student with low vision. An extensive listing of agencies and organizations that serve persons with visual impairments and a materials tote with consumable forms for teachers, parents, and students is included.

**Kit**  
1-08290-00 \$151.00

**Materials Packet Only**  
1-08290-01 \$32.00

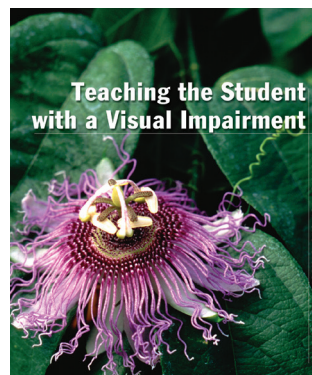

## Self-Esteem and Adjusting to Blindness: The Process of Responding to Life's Demands, 2nd Edition

Explores the development of self-esteem, attitudes toward blindness, and adaptability illustrated by biographies and autobiographies of people who are blind. Helps people examine their reactions, coping skills, and personal attitudes in order to live a positive and independent life.

**Braille**  
5-00500-00 \$178.00

**Print**  
L-96229-00 \$95.50

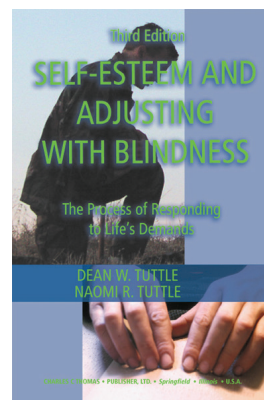

## Loving Me: A Guide to Creating and Presenting Workshops on Self-Esteem

Designed for those who seek to help people who are blind and visually impaired, their families, and the professionals who work with them explore the origin and expression of their self-esteem in a workshop format.

7-02500-00 \$278.00

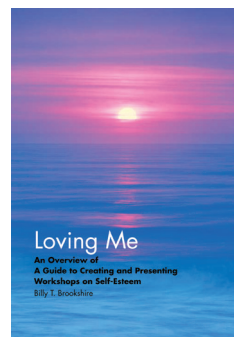



## Studio Recorder™ Software

A powerful digital recording and editing software package geared specifically for making recordings of the spoken word. Studio Recorder contains many features that make recording, editing, and proofreading audio books easy, including features not found in similar programs. Requires Windows® 7 or later.

**CD/ROM**  
**D-03600-00 \$200.00**

**Digital Download**  
**D-03600-ED \$200.00**



## The Impressor™ Braille Business Card Embosser

Easily create your own braille business cards! Similar to the stamp used by notary publics, the die which embosses braille on your card is custom-made with your information. Embosses up to 4 lines, 13 braille cells per line. Call 800-223-1839 to initiate an order.

**1-03380-00 \$217.00**

**Impressor Revised**  
**1-03380-01 \$119.00**



## Materials Carry-All

This sturdy, lightweight storage/transporting container is great for materials of all types. The side-opening design provides more usable space with better visibility of contents as compared to the previous model. Measures 10 1/2 x 27 x 16 inches, weighs 4 lbs.

**1-02592-00 \$60.00**

# Gift Section

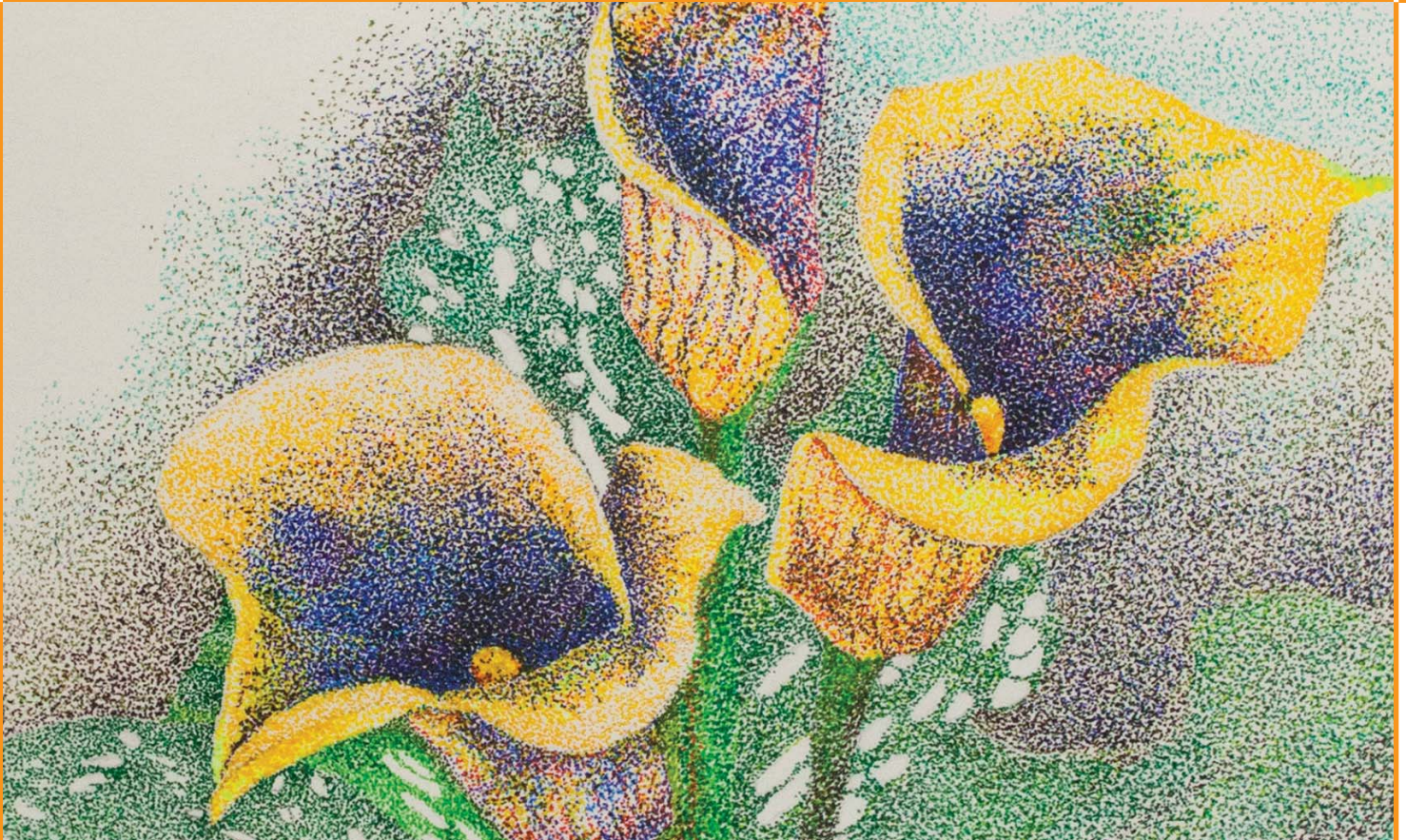

## APH InSights Art Calendar 2020

Twelve month large print/braille calendar features the artwork of visually impaired artists. Includes months, days, holidays, and moon phases. Pages fold over easily.

### Makes a Great Fund-Raiser

Art calendars can be purchased with a minimum order of 50 for fundraising projects. Your group's name can be printed and brailled on a special version of the cover. Fund-raising questions and orders should be directed to APH's Contract Administration Office, 1-800-223-1839.

**Note:** The APH Insights Calendar MAY be purchased with Federal Quota funds; however, quantity purchases of this calendar for fundraising purposes MAY NOT be purchased with Quota funds.

**5-18971-20 \$8.00**



APH InSights Calendar 2020

## Other Services From APH

### Other Services from APH

This section contains information on selected services offered by APH. For complete information about APH services, please visit [aph.org](http://aph.org) or call 1-800-223-1839.

### APH News – Your APH Connection

One of the best ways to learn about new products, services, and resources at APH!

To automatically receive your monthly link to the APH News, send an email to:

[aphinfo-request@iglou.com](mailto:aphinfo-request@iglou.com)

Include the following in the body of the email: Subscribe. Leave the subject line blank.

### APH Insights Annual Juried Art Competition and Exhibition

Each year APH sponsors a juried art competition and exhibition designed exclusively for blind and visually impaired artists of all ages. From the hundreds of entries received, works are chosen for exhibition at APH's Annual Meeting. Award winners are selected in each of nine categories; media may include sculpture, pottery, weaving, photographs, prints, paintings, etc. Artwork is judged on originality of concept, expressive use of media, and artistic excellence.

To enter APH InSights, contact the Special Programs Coordinator, Email: [insights@aph.org](mailto:insights@aph.org)

### The APH Blog

The APH blog is your go-to source for information about APH products, innovations, accessibility and happenings in the field of blindness. Follow our journey as we work to break down barriers and create a more inclusive world. You'll learn from leaders in the field and also hear stories from a diverse group of peers who will inspire and challenge you. Visit [aph.org](http://aph.org) and click on the "Articles" link in the footer menu to start reading.

### APH Social Media

Are you on social media? Follow us to stay up-to-date on everything happening at APH and in the field. From exciting announcements and contests, to tutorials and events.

Here's where you can find us:

Facebook: [@AmericanPrintingHouse](https://www.facebook.com/AmericanPrintingHouse)

Twitter: [@APHfortheBlind](https://twitter.com/APHfortheBlind)

Instagram: [@americanprintinghouse](https://www.instagram.com/americanprintinghouse)

Pinterest: [American Printing House](https://www.pinterest.com/AmericanPrintingHouse)

YouTube: [APH – American Printing House for the Blind](https://www.youtube.com/APHfortheBlind)

## Visit Our Museum!

Explore the fascinating educational history of people with vision loss when you visit our award-winning museum. Innovations, inventions, and products that made a difference are on exhibit, from the earliest tactile books to digital technology. Meet the many individuals whose work shaped the history of the American Printing House for the Blind, the largest manufacturer of educational products for people who are blind or visually impaired.

Guided tours of the APH factory are also available and take you behind the scenes where braille and tactile graphics are produced and audio books are recorded. It's FREE!

### Museum Hours (EST)

Monday-Friday  
8:30 a.m. to 4:30 p.m.

Saturday  
10:00 a.m. to 3:00 p.m.

Closed on holidays  
and Derby Day

### Factory/Museum Tour Hours

Monday-Thursday, twice daily,  
at 10:00 a.m. and 2:00 p.m.

Advanced reservations are required  
for groups of 10 or more.

Length of tour: approximately 1 1/2 hrs.

For more tour information, contact APH:  
502-895-2405 or 1-800-223-1839.



## Need Accessible Materials? APH Will Custom-Make Them for You!

Our state-of-the-art processes and exacting standards allow us to create custom braille, tactile graphics, enlarged print, and audio materials for your clients, customers, shareholders, and employees who are blind and visually impaired.

Please contact APH Contract Administration Dept. for a no-obligation cost estimate on your next project. 800-223-1839 (menu option 5: Braille Transcription Services or Custom Requests) or email: [contracts@aph.org](mailto:contracts@aph.org)

## Finding Tactile Graphics Templates is Easier Than Ever!

APH offers the free Tactile Graphic Image Library database. Teachers, transcribers, students, families, and paraprofessionals are able to register to use the image library to find and download tactile graphics that can be enhanced for your needs. Search the database by category or keyword. Offers 3D images and designs for the Tiger® Embosser.

Sign up for FREE to use the database at [imagelibrary.aph.org](http://imagelibrary.aph.org)

## Accessible Tests and Textbooks Department

Accessible Tests and Textbooks, offers a wide range of services. For more detail about any of these services, please visit [aph.org](http://aph.org)

### Tests: Extensive Services Offered

APH is prepared to assist with all phases of test accessibility, from item development and bias review through production, shipping, and product support. Tests offered through this department can be ordered in hard copy braille, large print, enlarged print, and digital formats. Accessible Tests also reviews online testing for accessibility to ensure all tests are accessible for all customers.

### Textbooks: The Accessible Media You Need

APH responds to the textbook needs of students who are blind and visually impaired by delivering custom-produced accessible textbooks in a variety of media in a timely manner. Accessible Textbooks staff processes all new textbook orders. We offer these media for textbooks:

#### Braille Textbooks, Hard Copy and Digital

Includes hard copy braille textbooks, as well as downloadable braille-ready files. Accompanying tactile graphics are available for purchase.

#### Large Print Textbooks, Hard Copy and Digital

APH Large Print textbooks can also be used on digital reading devices such as iPad®, Kindle®, Book Port™, Braille Plus 18™, and more. Many of the large print e-files contain image descriptions.

## For Questions About Accessible Tests or Textbooks, Contact

Jane Thompson, Director Accessible Tests and Textbooks Departments

Braille Improvement Department

502-899-2370 • [jthompson@aph.org](mailto:jthompson@aph.org) • [atic@aph.org](mailto:atic@aph.org)



# Magazine Subscriptions

Subscription Magazine	Accessible Format	Annual Fee (optional)
Reader's Digest®	Braille .....	\$174.00
	Cassette Tape (15/16, 4-track) .....	\$18.00
	Digital Flash Cartridge .....	\$33.00
	Digital Download .....	Donation
Newsweek®	Cassette Tape (15/16, 4-track) .....	\$90.00
	Digital Download .....	Donation

APH provides free Readers Digest or Newsweek in accessible formats for blind and visually impaired people across the country. If you or someone you know would benefit from this free service, please contact Customer Service at 1-800-223-1839 or [magazines@aph.org](mailto:magazines@aph.org) Gift subscriptions are available at the above rates. Non-U.S. citizens MUST pay the above subscription rates. Contributions to defray costs are welcomed.

Cassette and Flash Cartridge editions require a Talking Book-type tape player, which plays specially recorded tapes. These players are available on a free loan basis from the library in your state that serves visually impaired or physically disabled readers.

For more information or to support APH's accessible magazine program, call 1-800-223-1839, ext. 2 or visit [aph.org](http://aph.org) and search for development magazines. The American Printing House for the Blind, Inc. is a 501(c)(3) nonprofit organization. Gifts are tax-deductible.

**Note:** Reader's Digest, Large Print Edition is not published by APH, but is available directly from The Reader's Digest Large Print Edition / P.O. Box 8177 / Red Oak, IA 51591 / 1-800-807-2780 / [www.rd.com](http://www.rd.com)

Reader's Digest is a trademark of The Reader's Digest Association, Inc.; Newsweek is a trademark of Newsweek, Inc.



## Ayuda A Nuestros Clientes En Español

Nota para nuestros clientes hispano hablantes:

Nos complace proporcionar servicio al cliente en español por medio de correo electrónico. podemos ayudarle con sus preguntas acerca de pedidos, devoluciones, reparaciones o cualquier otra duda que usted tenga.

¿Sabía que APH ofrece cada vez más productos en español? Búsque estos productos en nuestra página de internet, o pida información a nuestros representantes.

Usted es muy importante para nosotros, gracias.

El personal de la American Printing House for the Blind, [cs@aph.org](mailto:cs@aph.org)

### APH OFRECE CIERTOS PRODUCTOS Y MANUALES EN ESPAÑOL

Boehm-3: Juego de Gráficas Agrandadas (manual y formas de registro),  
1-03880-00; 1-03883-00 ..... 13

Juego de Calendario para el Salón de Clases: 1-18973-00 ..... 99

Caja de Luz: Guía de Actividades. Favor de visitar nuestra página web para obtener más información.

    Nivel I: 7-08670-SP

    Nivel II: 7-08680-SP

    Nivel III: 7-08690-SP

Conexiones Táctiles: Libro de Guía. 7-08837-SP ..... 95

Zeitgeist: Máquina del Tiempo. 1-03974-SP ..... 156



# How to Order and Related Information Section Index



How to Order .....	178
Shipping Methods .....	179
Return Policy .....	183

Repair Policy & Warranties .....	184–185
Software, Apps, ePubs, and File Repository .....	181–182

## How to Order

### Order Online (U.S. Customers)

- Go to **aph.org** for accessible and secure ordering
- Friendly for synthetic speech and large print users
- One-time, easy account setup
- Purchase online using either credit card or federal quota funds

### Order by Email

- Send orders to **po@aph.org**
- We accept federal quota orders (signed by EOT), purchase orders, and orders from individuals via email
- Please include catalog numbers, product names, quantities, price each, and total amount due
- Please do not email your credit card information

### Order by Phone

- Call 1-800-223-1839 or 502-895-2405
- Please have your credit card ready

### Order by Fax

- Fax orders to 502-899-2284
- Please include catalog numbers, product names, quantities, price each, and total amount due
- Please do not fax your credit card information

### Order by Mail

- Mail a federal quota order form (signed by EOT), purchase order, APH order form, or a letter written in print or braille stating desired items and quantities. Please include check, money order, or your contact information for us to obtain credit card payment.
- Please do not mail your credit card information.

American Printing House for the Blind  
1839 Frankfort Ave  
Louisville, KY 40206

**Note:** Checks and money orders must be in U.S. dollars. Kentucky residents must include 6% sales tax.

## Pro Forma Invoices

- Submit a request online by searching for Pro Forma Invoices at **aph.org**
- Alternatively, submit a request via email, fax, or mail and include catalog numbers, product names, quantities, and preferred shipping method. We will send you a pro forma invoice showing product prices and shipping costs.
- Please allow 5 business days to be completed

## Shipping Methods

### Shipping within the U.S.

Most items ordered by or for people who are visually impaired will be shipped via Free Matter for the Blind, a free service provided by USPS. Please allow up to 2 weeks shipping time for items sent via Free Matter for the Blind. Customers needing a faster shipping option can contact Customer Service via phone, email, fax, or mail for a freight quote. Customers will be responsible for any upgraded shipping costs.

**Note:** When indicated, select items cannot be shipped via Free Matter and will require paid shipping.

### Shipping Outside of the U.S.

Some items ordered by or for people who are visually impaired can be shipped to most overseas destinations via Free Matter for the Blind (surface mail). The customer is responsible for the shipping cost of all other items requiring paid freight. Please contact Customer Service via phone, email, fax, or mail for a freight estimate. APH recommends shipment by Priority Mail International Airmail, as surface mail is much slower.

All export and/or import duties, brokerage fees, etc. are paid by the customer. Please check with your customs broker to make arrangements in advance.



## **Paid Shipping Options within the U.S.**

### **U.S. Postal Service® Priority Mail**

2–3 day delivery to any address (including P.O. boxes). No additional charge for Saturday delivery.

No Sunday or holiday delivery.

### **U.S. Postal Service® Express Mail**

Guaranteed next day delivery to most addresses (including P.O. boxes), 7 days a week, 365 days a year.

### **United Parcel Service® (UPS) Ground**

4–7 day delivery to street addresses only (no P.O. boxes).

No weekend or holiday delivery.

### **UPS 3-Day**

Guaranteed 3-day delivery to street addresses only (no P.O. boxes).

No Saturday, Sunday, or holiday delivery.

### **UPS 2-Day**

Guaranteed 2-day delivery to street addresses only (no P.O. boxes).

No Saturday, Sunday, or holiday delivery.

### **UPS Overnight**

Guaranteed next day delivery to street addresses only (no P.O. boxes).

Additional charges for Saturday delivery.

No Sunday or holiday delivery.

## **Further Assistance**

[aph.org](http://aph.org)

[cs@aph.org](mailto:cs@aph.org)

1-800-223-1839 or 502-895-2405

Fax: 502-899-2284



## Special Instructions

### Software

- To purchase a CD-ROM please submit an order via **aph.org**, or by email, phone, fax, or mail.
- To purchase a program as a digital download, first download the demo version of the software from our website **tech.aph.org**. Then submit an order via **aph.org**, or by email, phone, fax or mail. Within 24 hours we will email you a key code that transforms your demo into a full copy.

**Note:** Software purchases are all non-returnable.

### Purchasing Multiple Licenses

When placing your order please specify the exact number of licenses needed as well as the email address to send key codes. Your receipt from the transaction is your authorization to place the software on the appropriate number of computers, up to the maximum number of machines that you specified.

### Apps for iOS Devices

- Submit an order via **aph.org**, or by email, phone, fax, or mail.
- APH will email an Apple Content Code for each license that you order.
- **How to Install** – The end user will install [Math Robot, Talking Typer, Nearby Explorer] with their Apple Content Code by: opening App Store on device> select the “Featured” tab> at the bottom of the “Featured” screen select “Redeem”> enter the password for the device> follow instructions on “Redeem” screen.
- If purchased with Federal Quota funds the EOT is responsible for distributing Apple Content Codes to end users.

iOS is a trademark or registered trademark of Cisco in the U.S. and other countries and is used under license. Apple, VoiceOver, iPad, iPad mini, iBooks, Mac, and the Apple logo are registered trademarks of Apple Inc., registered in the U.S. and other countries. App Store is a service mark of Apple Inc. Amazon, Alexa and all related logos are trademarks of Amazon.com, Inc. or its affiliates. All rights to the Trademarks are the exclusive property of Amazon. Android, Google Places, Google Play, Google Play logo, Google Books, Google Assistant and Chrome are trademarks of Google Inc., Foursquare® is a trademark of Foursquare Labs, Inc. (“Foursquare”) in the U.S. and other countries. Windows is a registered trademark of Microsoft Corporation in the United States and/or other countries. Linux® is the registered trademark of Linus Torvalds in the U.S. and other countries. EPUB is a registered trademark of the IDPF. Radium is a registered trademark of Radium Foundation. Adobe Digital Editions is a registered trademark of Adobe Systems Incorporated in the United States and/or other countries. The Bluetooth® word mark and logos are registered trademarks owned by the Bluetooth SIG, Inc. Other trademarks and trade names are those of their respective owners.

## Nearby Explorer for Android Devices

- **Purchasing with Federal Quota:** Purchases must be made through the APH File Repository.
- For general information or for a direct download, go to **aph.org** and search for Nearby Explorer.
- **Purchasing with Credit Card:** Must be done through Google Play.
- Direct link: <https://play.google.com/store/apps/details?id=org.aph.avigenie>
- For general information about registering and purchasing files from Google Play please visit: <https://play.google.com/store/apps>

## eBooks (ePub Files)

After receiving an email from APH and clicking the eBook link:

- from an iOS device or Mac computer the title will open in iBooks
- from an Android device the title will open in Google Books
- on a Windows or Linux operating system you will need to download and install an ePub reader before being able to read this title. We recommend the Radium extension for the Chrome Browser or Adobe Digital Editions\*.

**\*Note:** Adobe Digital Editions does not support the interactive features built into the CVI Complexity Sequences eBook, however it reads the text correctly.

## APH File Repository

The APH File Repository offers various types of electronic files to make your textbook production / acquisition quicker and easier. Current file formats include Braille-ready files, (produced with Duxbury, Braille Blaster, etc.), Large Print files (PDF), and Text files (ASCII, Tagged formats, Word or RTF).

Quota funds may be used to pay the download fee, but Repository files are available by download only; they cannot be ordered over the phone or by mail.

Please contact Resource Services for additional information at 800-223-1839 x705 or [resource@aph.org](mailto:resource@aph.org)

## Important Icon Legend



**CVI Icon** Products with this icon may be appropriate for learners diagnosed with CVI. Comprehensive assessment should determine which products are best matched to your learner's needs.



**Safety Warnings Icon** Please note and follow the small parts choking hazard and other warnings indicated for certain APH products.



**Replacement and Optional Parts Available Icon** Products with available replacement parts are marked with this icon. Refer to the Replacement Parts Catalog on our website.



## Return Policy

### Defective Merchandise

APH makes every effort to inspect and test merchandise before it leaves our facility. If by chance you receive a defective item, please notify us within 30 days from the date item was shipped. If the item included a 1 year warranty please notify us within 1 year from the date item was shipped. We will repair or replace defective items at no cost to you. We reserve the right to choose whether the item will be repaired or replaced. For more information on warranties, please refer to the Warranty section below.

### Other Returns

We gladly accept returns on most APH products (exclusions listed below) for any reason within 60 days of the date the item was shipped, subject to the following conditions:

- Pre-authorization is required for any return. Please call, email, or write us and a Customer Service representative will provide you with a Return Authorization (RA) number and instructions for completing your return.
- Returned items must be undamaged and in resalable condition.

**Note:** The following items may not be returned for any reason other than defects.

- Software (free demos are available at [tech.aph.org](http://tech.aph.org))
- Apps
- eBooks
- Large print, braille, APH Press, or AFB Press books
- Custom orders

**Note:** The following books may not be canceled once production has begun.

- Large print (catalog prefixes 4-, A-L, F-, J-, L-, L-C, or M-)
- Braille (catalog prefixes A-B or T-N)
- APH Press or AFB Press (catalog prefix F-B)



**Downloadable Manuals** Most APH products have manuals available for immediate, free-of-charge downloading for printing or embossing as needed. Please visit [aph.org](http://aph.org) to download a manual.



**UEB Icon** Products with this icon are transcribed in Unified English Braille (UEB).



**New Product**



**Revised Product**

## General Repair Policy

If you are experiencing difficulty with an APH product, please call Customer Service at 800-223-1839 and explain the issue you are experiencing. It is possible we can solve your issue over the phone. If your product requires repair, please send it to:

APH  
 Attn: Repairs Department  
 1839 Frankfort Avenue  
 Louisville, KY 40206

Be sure to include a note with your contact information and any details regarding what needs to be repaired and/or the issues you are experiencing.

Payment is required for eligible out of warranty products prior to the completion of any repairs. Accepted forms of payment are as follows:

- Federal quota purchase order, which must be signed by the EOT.
- School or organization purchase order
- Check
- Credit card – If you opt to pay by credit card, note this when you send us your product and we will contact you for credit authorization.

## Products Under Warranty

If your product is still under warranty, we will repair or replace the item at no cost to you (subject to certain restrictions). Please ship the product to us along with a written description of the problem.

## Products Out Of Warranty – Flat Rate Fees

The following products carry a flat rate repair fee. Items deemed non-repairable will be returned to you without charge.

NB: Discontinued catalog number indicated by (d)

<b>Mini-Lite Box:</b> 1-08661-00 .....	\$65.00
<b>Light Box:</b> 1-08660-00 (d), 1-08669-00 (d) .....	\$155.00
<b>Perkins Brailers:</b> 1-00850-00 (d), 1-00860-00 (d), 1-00815-00 (current) .....	\$150.00
<b>Portable Sound Source:</b> 1-03040-01 (d), 1-03040-02 (d), 1-03045-00 .....	\$50.00
<b>Book Port DT:</b> 1-07200-00 (d) .....	\$50.00
<b>Book Port Plus:</b> 1-07191-00 (d) .....	\$50.00
<b>Joy Player:</b> 1-07089-00 .....	\$50.00



## Products Out of Warranty – Fee to be Determined for Repair

The following products do not have a set repair fee due to the range of prices for repair parts. Pre-payment of a non-refundable evaluation/handling fee is required. This fee includes the cost of return shipping by UPS.

NB: Discontinued catalog number indicated by (d)

**APH SMART Brailier by Perkins:** 1-00820-00 ..... \$200.00

**Perkins/APH Brailier:** 1-00800-00 (d) ..... \$200.00

The following products are NOT sent directly to APH for repair. Please contact Customer Service at 800-223-1839 or [cs@aph.org](mailto:cs@aph.org) for special instructions:

**Orion Plus Talking Graphing TI-84 Calculator:** (1-07340-00) ..... \$75.00

**Orion TI-30XS Multiview Talking Scientific Calculator:** (1-07330-00) ..... \$75.00

**Orbit Reader 20:** (1-07419-00) **purchased PRIOR to June 1, 2019** ..... \$80.00  
 (1-07419-00) **purchased AFTER June 1, 2019.** Contact Orbit Research directly at 1-800-606-7248 or [techsupport@orbitresearch.com](mailto:techsupport@orbitresearch.com).

Contact the Manufacturer directly for **WARRANTY** and **OUT OF WARRANTY** repairs on the following products:

**Braille Trail Reader** (1-07421-00) ..... Humanware: 1-800-722-3393

**MATT Connect** (1-03941-00) ..... Humanware: 1-800-722-3393

**Jupiter** (1-00370-00) ..... Freedom Scientific: 727-803-8600

**Sunu Band** (1-03140-00) ..... Sunu: 877-747-9677

**Video Mag HD** (1-03914-00) ..... Freedom Scientific: 1-800-444-4443

**Orbit Reader 20:** (1-07419-00) **purchased AFTER June 1, 2019:** Contact Orbit Research directly: 1-800-606-7248 or [techsupport@orbitresearch.com](mailto:techsupport@orbitresearch.com).

## Products That are no Longer Repaired:

**Handi-Cassette II** 1-07085-00 (d)

**Refreshabraille 18**  1-07445-01 (d)

**VisioBook**  1-03913-00 (d)

**Braille Plus 18** 1-07466-00 (d)

**Orion TI-36 Calculator** 1-07335-01 (d)

## Repair Warranty

There is a 90-day warranty for work performed by APH on repaired equipment. This warranty covers both labor and parts. As always, the warranty does not apply in cases of customer modification, misuse, or abuse of APH products. **Note:** Extended warranties do not cover replacement of electronic product accessories, including rechargeable batteries.



Abacuses ..... 53, 63

Accessible

- Magazines ..... 175
- Materials, Custom-made ..... 173
- Multiple Choice Answer Sheets ..... 17
- Textbooks ..... 174

Adapted Science Materials Kit ..... 66

Adapting Science for Students with VI ..... 69

Addendum 1 to the Nemeth Code ..... 168

Addition/Subtraction Table ..... 56

Address Book, EZ Track ..... 158

Adhesive, Sticky Dots ..... 41

**Advertisements**

- APH ConnectCenter ..... 1
- APH Press ..... 6
- Braille Trail Reader LE ..... 5
- Braille Tales ..... 4
- Code Jumper ..... 7
- Connect With Us Online! ..... 199
- Flip-Over FACES App ..... 200
- InSights Art Competition ..... 187
- Product Feedback ..... 189
- Social Media ..... 199

All Aboard! ..... 46

All-in-One Boards ..... 91

Alphabet Card Folder ..... 101

Alphabet Scramble ..... 31

Aluminum Diagramming Foil ..... 97

Analog Clock Model ..... 64

AnimalWatch Vi Suite ..... 49

Answer Sheets, Multiple Choice ..... 17

Antique Ivory Opaque Paper ..... 118

Armadillo Army ..... 134

Art Competition and Exhibition ..... 172

Art Instruction, Time for Art ..... 76

Assessment ..... See Test

Audio Recording, Digital:  
Studio Recorder ..... 170



Backpack, Transition Tote System ..... 149

Ball

- APH Sound ..... 80
- Kit, Sound Adapted Tangle ..... 39
- Rib-It ..... 80

BANA Braille  
Transcription Codebooks ..... 167–168

Baseball, Touch ‘em All ..... 161

Basic Science Tactile Graphics ..... 69

Basic Tactile Anatomy Atlas ..... 69

Beads,

- Braille ..... 77
- Giant Textured ..... 36

Beginner’s

- Abacus ..... 63
- Writing Paper ..... 113

Best for a Nest, The ..... 24

Big Cell ..... 103



Binder	
Floppy, Braille .....	120
Krebs', 19-Ring .....	119
Blog, APH .....	172
Board(s)	
All Aboard! Magnetic/Dry Erase .....	46
All-in-One .....	91
Invisiboard .....	127
Magnetic/Dry Erase, Large .....	85
Shape .....	38
Tri-fold .....	127
Board games	
Games of Squares .....	164
Scattered Crowns .....	161
TREKS .....	163
Web Chase .....	162
Boehm-3 .....	13
Bold Line	
Graph Sheets .....	118–119
Paper .....	116–117
Book	
Port DT .....	146
Wizard .....	147
Boxes, Calendar, Expandable .....	96
Braille Labels and Sheets .....	87
Braille	
Alphabet/Numbers Card .....	151
Badges .....	147
Beads .....	77
Binders, Floppy .....	120
Clock Face Sheets .....	64
Code for Chemical Notation .....	168
Contraction(s)	
Cards .....	44
Quick Check .....	101
DateBook .....	155
Dividers, 3-Hole Punch .....	114
Documents, Covers for .....	114
Envelopes for, Mailing .....	114
Instruction: Lots of Dots .....	42

## Get Creative, Enter APH InSights! APH InSights Annual Juried Art Competition and Exhibition

Each year APH sponsors a juried art competition and exhibition designed **exclusively for blind and visually impaired artists of all ages**. Works are chosen for exhibition at APH's Annual Meeting. Award winners are selected in each of nine categories.

Submissions to APH InSights may include sculpture, pottery, weaving, photographs, prints, paintings, mixed media, and collage.

**To enter, contact the Special Programs Manager, [insights@aph.org](mailto:insights@aph.org)**

**APH has created a calendar featuring artwork from APH InSights, see page 171.**



Meterstick	61
Notebooks	114, 119
Paper	115–116
Plastic Binder Envelope	120
Pocket Folders	120
Quick-Note, MiniBook	155
Reading Program: BOP	106–111
Slates, Styluses, Erasers	91–93
Student Readers, WRS	44–45
Student Starter Pack	93
Super-Sized Folders	120
Swing Cell Compact	103
Tales	4
Touch and Tell	104
Trail Reader LE	5
Transcriber's Kits	112
BrailleBlaster	144
BrailleBuzz	85
Braille/Large Print Rulers	60–61
Braille/Print Weekly Reader	104
Brailler, Visual	146
Braillewriters (Braille)ers)	113
Braillewriting Dot by Dot	93
Brannan Cubarithm Slate and Cubes	59
Brigance	15–16
Bright Line Reading Guide	126
Bright Shapes Knob Puzzles	21
Budgeting, Money Handling and	157
Building on Patterns Series (BOP)	106–111



Calculator, Orion TI-84 Plus Talking Graphing	53
--	----

#### Calendar

APH InSights Art	171
Boxes, Expandable Kit	96
Classroom Kit	99
Everyday Activities	24
EZ Track	158
Individual Kit	99
Box Stabilizer	96

#### Card(s)

Chart Kit	99
Colored Shape	132
Drill, Math	59
Expanded Dolch Word Score	161

Charger, 2 AMP USB	147
--------------------	-----

Checkbook, Adapted Practice	157
-----------------------------	-----

Child-guided Strategies	16
-------------------------	----

#### Clock

Analog Model	64
Face Sheets in Braille	64

Clothing Tape, Tactile	156
------------------------	-----

Codebooks, BANA	167–168
-----------------	---------

Code Jumper	7
-------------	---

Collegiate Boldline Spiral Notebook	116
-------------------------------------	-----

Color Star	154
------------	-----

#### Color-by-Texture

Circus Coloring Pages	77
Marking Mats	77



Coloring the Garden, LOD ..... 42

Colorino ..... 156

Compass for Math/Art, Tactile ..... 55

Constructo Set, Wooden ..... 164

Consumable

    Hundreds Chart ..... 56

    Number Lines ..... 52

Counting

    1 2 3, LOD ..... 42

    Method: Abacus ..... 62

    Quick Pick ..... 60

Countries and Continents:

    Braille Transcriber’s Kit ..... 112

    Covers for Braille Docs ..... 114

Cranmer Abacus

    Hands-One Experience with the ..... 62

    Using the ..... 62

Crossings With No Traffic Control ..... 136

Crossword ..... 162

Custom Graphics:

    Tactile Graphics Kit ..... 97

CVI

    Book Builder ..... 122

    Complexity Sequences ..... 133

    Increasing Complexity Pegboard ..... 124

    Information and Product List ..... 9

    Invisiboard ..... 127

    Match Sticks ..... 126

    Swirly Mats ..... 132–133

Cylinder Set, Sensory ..... 38



DAISY book readers

    Book Wizard ..... 147

    Book Port DT ..... 146

Deafblind Pocket Communicator ..... 154

Decision Making Guide ..... 123

Denver, Guide Dog (video) ..... 139

Desktop Stick-On Number Lines ..... 52–53

Desk Top Reading Stand ..... 102

Developmental Guidelines

    Infants with VI, Dev. Guide ..... 24

    Impairments, Parent and Their ..... 25

**We’d like to know what YOU think as a user of APH products!  
What did you like about a product? What could be improved?**

Submit product feedback using our handy online feedback form.

Your feedback will be passed on to the product developer or other appropriate APH staff members. We’ll use YOUR opinions when we evaluate products.

Search for “feedback form” at **aph.org**.

Give us your two cents today!



Diagramming Kit: Picture Maker	141
Digital, Studio Recorder	
Audio Recording, Studio Recorder	170
Light Box Artwork	132
Talking Book Cartridge	145
Dot by Dot, Braillewriting	93
DNA-RNA Kit	67
DNA Twist	67
DRAFTSMAN	97
Draw2Measure Protractor	50
Drill Cards, Math	59



Early Braille Tradebooks (EBT)	88–90
Earth Science Tactile Graphics	68
Easel, Portable Reading, GrandStand	102
Echolocation/FlashSonar	137
Effective Use of Objects	35
Embossed	
Graph Sheets	118–119
Pencil Writing Paper	112
Emmy's Town, Toodle Tiles	134
English Measurement Rulers	61
ENVISION	125
Everybody Plays	80
Every Child Can, VIPS Video	41
Everyday Activities Calendar	24
Expandable Calendar Boxes	96
Expanded Beginner's Abacus	63

Expanded Dolch Word Cards, UEB	44
Experiential Learning	25
Explorer Bright Ray	124
EZ	
Fill Liquid Sensor	157
Test Battery Tester	156
Track Products	158
EZeeCOUNT Abacus	53



Familiar Object Pictures	132
Feel 'n Peel Products	94–95
Financial Record Keeper, EZ Track	158
Fine Motor Dev. Materials	35
Fitness Kits	82
Flashlight Kit, Variable Beam	124
Flexible Rulers	61
Flip-Over	
Concept Books	105
FACES App	200
Floppy Braille Binder	120
FOCUS in Mathematics	55
Foil, Aluminum Diagramming	97
Folders	120
FoldRite	78
Form Board Kit, Puzzle	37
Four Little Corners	23
Four Line 8-dot Slate	92
Fractional Parts of Wholes Set	58



Functional

- Activities/VI Preschoolers,  
HANDS ON ..... 35
- Skills Assessment ..... 153

FVA (Functional Vision Assessment)

- Swirly Mats ..... 132–133

- FVLMA ..... 15



Game

- Kit ..... 162
- Quick Pick Series ..... 60
- Scattered Crowns ..... 161
- Six Little Dots Game of Cards ..... 23
- TREKS ..... 163
- Web Chase ..... 162

Games for People with

- Sensory Impairment ..... 80

- Games of Squares ..... 164

- Genetic Code Large Print Braille ..... 70

- Geometric Forms ..... 57

- Geometro ..... 54

- Getting to Know You ..... 150

- Glasses, UltraLens ..... 127

- Giant Textured Beads ..... 36

- Globe, World ..... 73

- GlowDice ..... 161

- Going Places ..... 81

- GrandStand ..... 102

- Graph Sheets, All ..... 118–119

Graphic(s)

- Aid for Mathematics ..... 58
- Art Tape ..... 96
- Image Library, Tactile ..... 174
- Tactile, Geometry ..... 57

Orion TI-84 Plus Talking

- Graphing Calculator ..... 53

Gross Motor

- Development Curriculum ..... 81



- Handheld Magnifier, Video Mag HD ..... 126

Hands-on Experience

- Cranmer Abacus (video) ..... 62

- HANDS ON: Functional Activities ..... 35

Hatlen Center Guide,

- Quick & Easy ECC ..... 149

- Headphones, Stereo ..... 147

- Holder for Slate ..... 92

How to Order and

- Related Information ..... 177–185

- Hundreds Chart, Consumable ..... 56



- Illinois Braille Series, UEB ..... 167

- Impressor, The ..... 170

- Individual Calendar Kit ..... 99

- Individual Study Screen ..... 124

- InSights Art Calendar ..... 171

- IntelliTactiles Pre-Braille Concepts ..... 98

Interactive U.S. Map	74
Intervention Continuum	11
Invisiboard	127



JAWS and ZoomText	145
Joy Player, The	34
Jumbo Work/Play Tray	39
Jump Rope to Fitness Kit	82
Jupiter Portable Magnifier	144



Keitzer Check Writing Guide	154
Krebs' Binder	119



Labeling, Marking, and Organization	159
Labels and Sheets, Brailleable	87
Laptime and Lullabies	20
Learning	
My ABC's, LOD	42
Nemeth Braille Code, The	168
Learn Keys: Verbal Keyboard Feedback	101
Letter Folding Tool: FoldRite	78
Life Science Tactile Graphics	69
Light Boxes	129
Light In-Sight	67

Lighting Guide Kit	131
Line Paths:	
Flip-Over Concept Books	105
Line Slate, Tactile Graphic	93
Liquid Sensor, EZ Fill	157
Literacy, On the Way	26-29
Lots of Dots (LOD) Series	42
Low Vision Simulators	123
Loving Me	169



Magazines	
SQUID Tactile Activities	164
Subscriptions, accessible editions	175
MagneTachers Magnetic Labels	159
Magnifier,	
Jupiter Portable	144
Video Mag HD, handheld	126
Mailing Envelopes for Braille	114
Map(s)	73-74, 112
Marking Mat(s)	
Tactile	111
Color-by-Texture	77
Materials, custom-made	173
Mats, Swirly	132-133
Match Sticks	126
Match-It-Up Frames	85
Matching Blocks, Textured	36
Materials	
Carry-All	170
Light Box	130



MathBuilders Kits ..... 52

Math(ematics)

    Braille Transcriber’s Kit ..... 112

    Drill Cards ..... 59

    Flash..... 50, 143

    Graphic Aid for..... 58

    Kit, FOCUS in ..... 55

    Nemeth Code Reference Sheet ..... 59

    Quick Pick ..... 60

    Robot ..... 48

    Tutorial, UEB ..... 51

MATT Connect ..... 143

Medical Record Keeper, EZ Track ..... 158

Meterstick ..... 61

Metric-English Measurement Ruler..... 61

Miniguide US ..... 138

MiniBook Braille  
Quick-Note Products ..... 155

Mini-Lite Box..... 129

Mini-Lite Box Overlays ..... 128

Money Handling and Budgeting ..... 157

Money Talks Software ..... 157

Moving Ahead Series ..... 32

Multiple-Choice Answer Sheets..... 17

Multiple Disabilities Products..... 11

Multiplication/Division Table..... 56

Museum, APH..... 173



National Geographic Atlas ..... 73

Nearby Explorer ..... 137–138

Nemeth Code

    for Mathematics and  
    Science Notation ..... 168

    Ref. Sheet for Basic Math..... 59

Nemeth Tutorial ..... 51

Newsweek Subscription..... 175

NewT Kit ..... 14

Notebook(s) ..... 114, 116, 119–120

Number Lines ..... 52–53



Objects, Effective Use of, ..... 35

O&M

    Crossings With No Traffic Control ..... 136

    Family Booklet Software ..... 139

    Miniguide US ..... 138

    Picture Maker..... 141

    Portable Sound Source..... 81

    Quick-Draw Paper ..... 98

    Step-by-Step ..... 140

    Sunu Band ..... 152

    Tactile Graphics ..... 139

    Tactile Town ..... 137

    Trivia..... 139

    Wheelchair Users w/VI, for ..... 140

One-Foot Braille Rulers ..... 61

On the Way to Literacy  
(OTWL) Series ..... 26–30

Orbit Reader 20 ..... 146

Ordering and Related Info. .... 177–185



Organizers	
Braille DateBook .....	155
EZ Track Products .....	158
Orion TI-84 Plus Talking Graphing Calculator .....	53
Outline Maps of the U.S. ....	74



Padlock, Push Button .....	159
Paint by Number Safari	
Tropical Rainforest .....	76
Under the Sea .....	76
Paint Pot Palette .....	77
Paper .....	97–98, 112–113, 115–119
Parents and Their Infants w/Visual Impairments (PAIVI) .....	25
Parenting With a VI .....	25
Parquetry Set, Seated .....	126
Parts of a Whole: Flip-Over Concept Books .....	105
Parts of Wholes Set, Fractional .....	58
PATTER: Preschool Attainment Through Typical Everyday Routines .....	25
Peg(s)	
Kit .....	37
Pegboard, and .....	131
Slate .....	93
Textured .....	36
Periodic Table .....	70
Perkins Brailers .....	113
Picture Maker .....	141

Place Value Setter .....	48
Plexiglas	
Blocks/Spinner .....	131
Spinner and Spinner Patterns .....	131
PermaBraille .....	116
Pocket-Size Notebook .....	119
Pop-A-Cell .....	103
Portable Sound Source .....	81
Pouring Aid, EZ Fill .....	157
Practice2Master Fractions .....	49
Preschoolers, HANDS ON: Functional Activities .....	35
President's Message .....	2
Prevocational Skills Development Materials .....	78
Protein Synthesis Kit .....	66
Protractors .....	58
Pumpkin Puzzles .....	31
Push Button Padlock .....	159
Puzzle(s)	
Bright Shapes Knob .....	21
Crossword .....	162
Form Board Kit .....	37
Map, U.S. ....	74
Slide, Twist 'N Solve .....	163
SQUID Tactile .....	164
Tactile Tangrams .....	50
Talking Word .....	163
Word Quest .....	162



Quick

- Check ..... 101
- Draw Paper ..... 98

Quick & Easy ECC:

- Hatlen Center Guide ..... 149
- Icon Poster ..... 148

Quick Pick Series ..... 60



Reach & Match ..... 21

Reach for the Stars ..... 24

ReadWrite Stands ..... 102

Reader's Digest Subscription ..... 175

Reading

- Guide, Bright Line ..... 126
- Stands ..... 102–103

Reclaiming Independence (video) ..... 155

Recording Device, APH SoundPage ..... 30

Reflection & Refraction Kit,  
Light In-Sight ..... 67

Refreshable Braille Display, Braille Trail  
Reader LE ..... 7

Returns Policy ..... 183

Rib-It Balls ..... 80

Rigby, EBT ..... 88–90

Robot, Math ..... 48

Rolling Into Place ..... 41

Rolling Right Along Construction Kit ..... 41

Rulers ..... 60–61



SAM: Symbols and Meaning ..... 95

Scattered Crowns:

Tactile Attribute Game ..... 161

Science

Adapting, for Students  
with Visual Impairments ..... 69

Basic, Tactile Graphics ..... 69

Materials Kit, Adapted ..... 66

Tactile Graphics, Life ..... 69

Score Card Set ..... 161

Screen, Individual Study ..... 124

Seated Parquetry Set ..... 126

See Like Me:

Low Vision Simulators ..... 123

Select Switch ..... 34

Self-Esteem and Adjusting  
with Blindness ..... 169

Sense of Science Series ..... 71

Sensory

Cylinder Set ..... 38

Impairments, Product List ..... 11

Learning Kit (SLK) ..... 34

Services from APH ..... 172–176

Setting the Stage ..... 104

Shape Board ..... 38

Shipping Methods ..... 179–180

Signature Guide, APH ..... 159

Six Little Dots ..... 23

Skeleton, Touch, Label, and Learn ..... 70

SlateHolder ..... 92



Slates/Styluses/Erasers .....	91–93	Snap Circuits Jr Access .....	143
Slate and Cubes, Brannan Cubarithm .....	59	Spangle Tangle .....	39
Slide, Twist, ‘N Solve Tactile Brain Teaser .....	163	Spanish Products List .....	176
Small, Medium, & Large Circles Sets .....	38	Spinner Overlays for the Light Box .....	128
SMART Braille .....	113	Spiral Pocket Notebook .....	120
Social Media, APH .....	172, 199	SQUID Tactile Activities Magazines .....	164
Software		StackUps .....	56
Armadillo Army .....	134	STACS .....	96
Book Wizard .....	147	Stands, Reading .....	102–103
BrailleBlaster .....	144	State Maps Collection .....	74
JAWS and ZoomText .....	145	Step-by-Step: An Interactive Guide to Mobility Techniques .....	140
Learn Keys .....	101	Stereo Headphones .....	147
Math Flash .....	50	Sticky Dots Adhesive .....	41
Money Talks .....	157	Storybook(s)	
O&M Family Booklet .....	139	Alphabet Scramble .....	31
Ordering .....	181–182	Bear Hunt .....	22
Studio Recorder .....	170	Best for a Nest, The .....	24
Talking Typer .....	100	Early Braille Tradebooks .....	88–90
Talking Word Puzzles .....	163	Everybody Plays! .....	80
Teacher’s Pet .....	16	Four Little Corners .....	23
Termite Torpedo .....	134	Holy Moly .....	21
Toodle Tiles .....	134	Moving Ahead Series .....	32
Sorting Circles/Shapes, Textured .....	55	On the Way to Literacy Series .....	26–30
Sound		Rolling Into Place .....	41
Adapted Tangle Ball Kit .....	39	Six Little Dots .....	23
Balls, APH .....	80	Student Starter Pack .....	93
Matching Boards .....	37	Student Workbook Kit for Geometro .....	54
Source .....	81	Studio Recorder .....	170
SoundPage, APH .....	30	Study Screen, Individual .....	124
		Styluses, All .....	92
		Sunu Band .....	152

Super-Sized Folders ..... 120  
 Swail Dot Inverter ..... 98  
 Swing Cell Compact ..... 103  
 Swirly Mat Sets ..... 132–133



Tactile

Algebra Tiles ..... 49  
 Anatomy Atlas, Basic ..... 69  
 Attribute Game  
 Scattered Crowns ..... 161  
 Book Builder Kit ..... 86  
 Brain Teaser, Slide, Twist,  
 'N Solve ..... 163  
 Compass for Math/Art ..... 55  
 Connections ..... 95  
 Demonstration Thermometer ..... 67  
 Drawing Board, DRAFTSMAN ..... 97  
 Editing Marks Kit ..... 46  
 Feel 'n Peel ..... 94–95  
 Game: Web Chase ..... 162  
 Instruction: Setting the Stage ..... 104  
 Marking Mat ..... 111  
 Punnett Squares ..... 70  
 Protractors, and Large Print ..... 58  
 Tangrams ..... 50  
 Town: 3-D O&M Kit ..... 137  
 Treasures ..... 35  
 World Globe ..... 73  
 World Maps ..... 73

Tactile Graphic(s)

Basic Science ..... 69  
 Image Library (TGIL) ..... 174

Kit ..... 97  
 Kit, Geometry ..... 57  
 Life Science ..... 69  
 Line Slate ..... 93  
 O&M ..... 139  
 TADPOLE Kit ..... 14  
 ToAD Kit ..... 14  
 Talking  
 Book Cartridge, Digital ..... 145  
 Calculator ..... 53  
 Color Identifier, Colorino ..... 156  
 Cooking Thermometer ..... 157  
 GlowDice ..... 161  
 Software, Math Flash ..... 50  
 Time Machine, Zeitgeist ..... 156  
 Typewriter ..... 100  
 Word Puzzles ..... 163  
 Tangle  
 Ball Kit, Sound Adapted ..... 39  
 Toy ..... 39  
 Tape  
 Graphic Art ..... 96  
 Tactile Clothing ..... 156  
 Teach Me to See (video) ..... 125  
 Teacher's Pet ..... 16  
 Teaching  
 the Student with a Visual  
 Impairment (TSVI) ..... 169  
 Street Crossing to Students w/Vi ..... 136  
 Touch ..... 104  
 Teen Scene (video) ..... 125



Tennis Kit, 30-Love ..... 82

Termite Torpedo ..... 134

Texture: Flip-Over Concept Books ..... 105

Textures

    Beads, Giant ..... 36

    Matching Blocks ..... 36

    Paper Collection ..... 97

    Pegs ..... 36

    Shapes, Geometric ..... 141

    Sorting Circles/Shapes ..... 55

    Strips ..... 141

Thermometer

    Tactile Demonstration ..... 67

    Talking Cooking ..... 157

Time for Art ..... 76

ToAD Kit ..... 14

Toodle Tiles ..... 134

Toss-Away Rulers ..... 60

Touch and Tell ..... 104

Touch ‘em All Baseball ..... 161

Touch, Label and Learn ..... 70

Tours of APH ..... 173

Toy, Tangle ..... 39

Transcription, Braille,  
Code Books, BANA ..... 167–168

Transition Tote System ..... 149

Transparent CCTV Rulers ..... 61

Travel Device, Miniguide US ..... 138

Trays ..... 39–40

TREKS ..... 163

Tri-fold Board ..... 127

Twist, Turn, & Learn ..... 35



UEB Math Tutorial ..... 51

UltraLens ..... 127

USB Charger, 2 AMP ..... 147

Using the Cranmer Abacus ..... 62

U.S. & Canada Atlas ..... 74

U.S. Puzzle Map ..... 74



Variable Beam Flashlight ..... 124

Venn Diagram Template Kit ..... 57

Video Mag HD ..... 126

Video List ..... 165

VIPS@Home Program ..... 33

VIPS Video Library Series ..... 40–41

Visual Braille app ..... 146



Walk/Run for Fitness Kit ..... 82

Warranty/Repairs ..... 184–185

Web Chase ..... 162

Weekly Reader,  
Print/Braille Edition ..... 104

What is IT? Kit ..... 21

Wheatley Tactile Diagramming Kit:  
Picture Maker ..... 141





Wilson Reading System (WRS) ..... 44

Woodcock-Johnson (WJ IV) ..... 104

Wooden Jr. Constructo Set ..... 164

Word

    Associations, Tactile ..... 99

    Cards, Expanded Dolch ..... 44

    PlayHouse ..... 44

    Quest Puzzles ..... 162

Work-Play Trays ..... 39–40

World at Your Fingers ..... 73

World

    Globe, Tactile ..... 73

    Maps, Tactile ..... 73



Yardstick, LP/Braille ..... 61

Young Children

    Fine Motor Development Materials ..... 35

    Literacy, On the Way to ..... 26–30

    Tactile Treasures ..... 35



Zeitgeist Talking Time Machine ..... 156

ZoomText, JAWS and ..... 145

## Connect With Us Online!



# Flip-Over FACES

Flip-Over FACES App allows a child to casually explore facial expressions within a fun and versatile context. Hundreds of facial expressions can be generated by changing the eyebrow position, eye direction, and mouth type. Multiple hairstyle and eyewear options are available to add interest or visual complexity.

This FREE, interactive app is specially designed for students with low vision and a cognitive level of 5 years of age or older. Students with additional disabilities, such as autism and language delays, may also benefit from this app. Sighted students and adults are invited to enjoy the app as well.



## Features

- Available for iOS® devices (Android™ app anticipated by fall 2019)
- High contrast colors of various facial features and accessories
- Sections of the displayed face can be swiped with one, two, or three fingers to change eyebrow position (top section), eye direction (middle section), and mouth shape (bottom section)
- Various hairstyle and eye accessory options are available
- An audio description of the displayed face can be activated
- The background color toggles between black and white depending on ideal visual contrast for the student and personal preference
- Favorite faces (limit of 20 at a time) can be saved in a personal folder for later retrieval and sharing with friends
- Easy-to-access how-to instructions, with or without VoiceOver/TalkBack are available

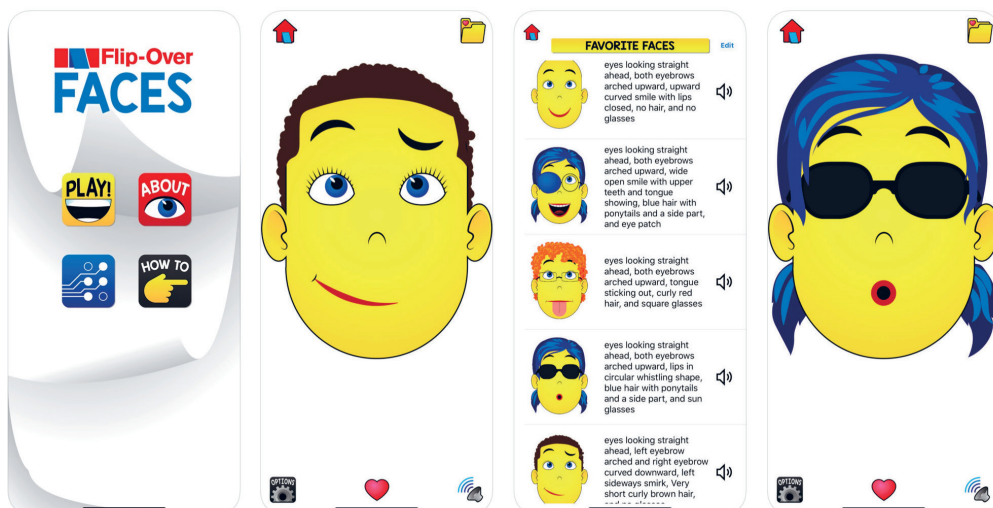

Download the Flip-Over FACES App at: <https://itunes.apple.com/us/app/flip-over-faces/id1303703530>.

# Federal Quota Funds Could Help Purchase APH Materials For Your Students

The federal Act to Promote the Education of the Blind provides funds for accessible educational materials for eligible students who meet the definition of blindness. An annual registration of eligible students determines a per capita amount of money specifically designated for the purchase of educational materials produced by the American Printing House for the Blind (APH). **These funds are credited to Federal Quota accounts** maintained and administered by APH and its Ex Officio Trustees throughout the United States and Outlying Areas.

## Who is Eligible?

While there is **no chronological age limit for eligibility, for students to be eligible to participate in the Federal Quota Program, they MUST fulfill the following requirements:**

- **Meet the definition of blindness (MDB)** — a central visual acuity of 20/200 or less (using a Snellen chart or an acuity determined in Snellen equivalents) in the better eye with the best correction or a peripheral field of vision no greater than 20 degrees or **function at the definition of blindness (FDB)**—when visual function meets the definition of blindness as determined by an eye care specialist (ophthalmologist or optometrist) or other medical doctor such as a neurologist. Students in this category manifest unique visual characteristics often found in conditions referred to as neurological, cortical, or cerebral visual impairment (e.g., brain injury or dysfunction).
- Be enrolled in a formally organized public or private, nonprofit educational program of less than college level. (Adult students previously enrolled in college level programs, however, ARE eligible.)
- Infants, preschool, and school-aged students must be enrolled with the registering school or agency on the first Monday in January.
- Adult students must be registered for at least 12 weeks for a minimum of 20 hours per week of documented instruction of less than college level, during the preceding calendar year (twelve weeks do not have to be consecutive). Social and leisure programs do not qualify as instruction; however, student practice to develop skills can be included in instructional hours.
- As of the 2018 census, each infant, preschool, or school-aged student must have a signed parent permission form to be registered in the Federal Quota Program, as well as adults with a guardian.

## Who are the Ex Officio Trustees?

For each residential school for the blind, state department of education, or agency for the blind that participates in the Federal Quota Program, an Ex Officio Trustee of the American Printing House for the Blind must be designated. Each Ex Officio Trustee is entrusted with the administration of the Federal Quota Program within his or her system.

## Want More Information?

For more information about the Federal Quota program, visit [aph.org/federal-quota](http://aph.org/federal-quota) or call **1-800-223-1839, ext. 257**. On our website, you can find contact information for the Ex Officio Trustees in your state. These Trustees can give you the specific information about whether your student may qualify for APH materials purchased with Federal Quota funds.



AMERICAN  
PRINTING  
HOUSE

1839 Frankfort Avenue  
Louisville, KY 40206-3152

Prefer not to receive catalogs in the future? It's easy to opt out. Send an email to [catalogs@aph.org](mailto:catalogs@aph.org).

## Our New Website!

Take a new look at an old friend!

Have you seen the new [aph.org](http://aph.org) website? Not only is our new site accessible, but it has also been streamlined and reorganized so the information you are looking for is easier to find. Our product pages have also been expanded to include detailed descriptions and photos, specification information, and much more.

[aph.org](http://aph.org)

